

foodproof[®]

StarPrep[®] Two Kit

Yeast & Mold

Product Instructions

Documentation for the rapid extraction of DNA from yeast
& mold for direct use in PCR

Product No. KIT230177

foodproof®
StarPrep® Two Kit
YEAST & MOLD

Store kit at 15 °C to 25 °C
FOR *IN VITRO* USE ONLY

Product No. KIT230177
42 mL volume

Manual:
Revision A, December 2023

TABLE OF CONTENTS

1. OVERVIEW	4
1.1 General Information.....	4
1.2 Applicability	4
1.3 Kit Contents.....	5
2. INSTRUCTIONS	6
2.1 Required Material	6
2.2 Precautions and Preparations	8
2.3 Workflows.....	9
2.3.1 Yeast and Mold - Quantification	9
2.3.1.1 Extraction Procedure A	11
2.3.1.2 Extraction Procedure B	14
2.3.1.3 Extraction Procedure C	17
2.3.1.4 Extraction Procedure D	20
2.3.1.5 Extraction Procedure E	23
2.3.2 Yeast and Mold - Qualitative Detection	27
2.3.2.1 Extraction Procedure F.....	28
2.4 Troubleshooting.....	31
2.5 Support.....	32
3. ADDITIONAL INFORMATION.....	33
3.1 General Information.....	33
3.2 Reference Number	34
3.3 Change Index	34

OVERVIEW

1. OVERVIEW

The foodproof® StarPrep® Two Kit is designed for the rapid preparation of DNA from bacteria or yeast and mold for direct use in PCR. The extracted DNA can be used directly in any PCR application. The StarPrep Two Lysis Buffer eliminates the need for hazardous organic extractions or chaotropic agents. The entire DNA preparation can be performed in a single tube, minimizing handling steps and exposure to hazardous material. The reduced number of handling steps saves time. Transfer steps of DNA-containing extracts are not necessary, thus cross-contamination risks are minimized.

1.1 General Information

Number of Reactions

The kit is designed for 96 reactions.

Storage Conditions

Store at 15 to 25 °C.

The components of the foodproof StarPrep Two Kit are guaranteed to be stable through the expiration date printed on the label.

1.2 Applicability

The lysis buffer is optimized for the preparation of various types of sample material, including enrichment cultures and direct samples. The sample volume varies depending on which matrix is being tested. For very cloudy supernatants, or samples containing inhibitors, a reduction of the sample volume (e.g., 200 µL) may enhance the DNA isolation efficiency. The quality of the DNA obtained with the lysis buffer is suitable for any PCR application.

1.3 Kit Contents

A schematic representation of the foodproof StarPrep Two Kit with all its components.

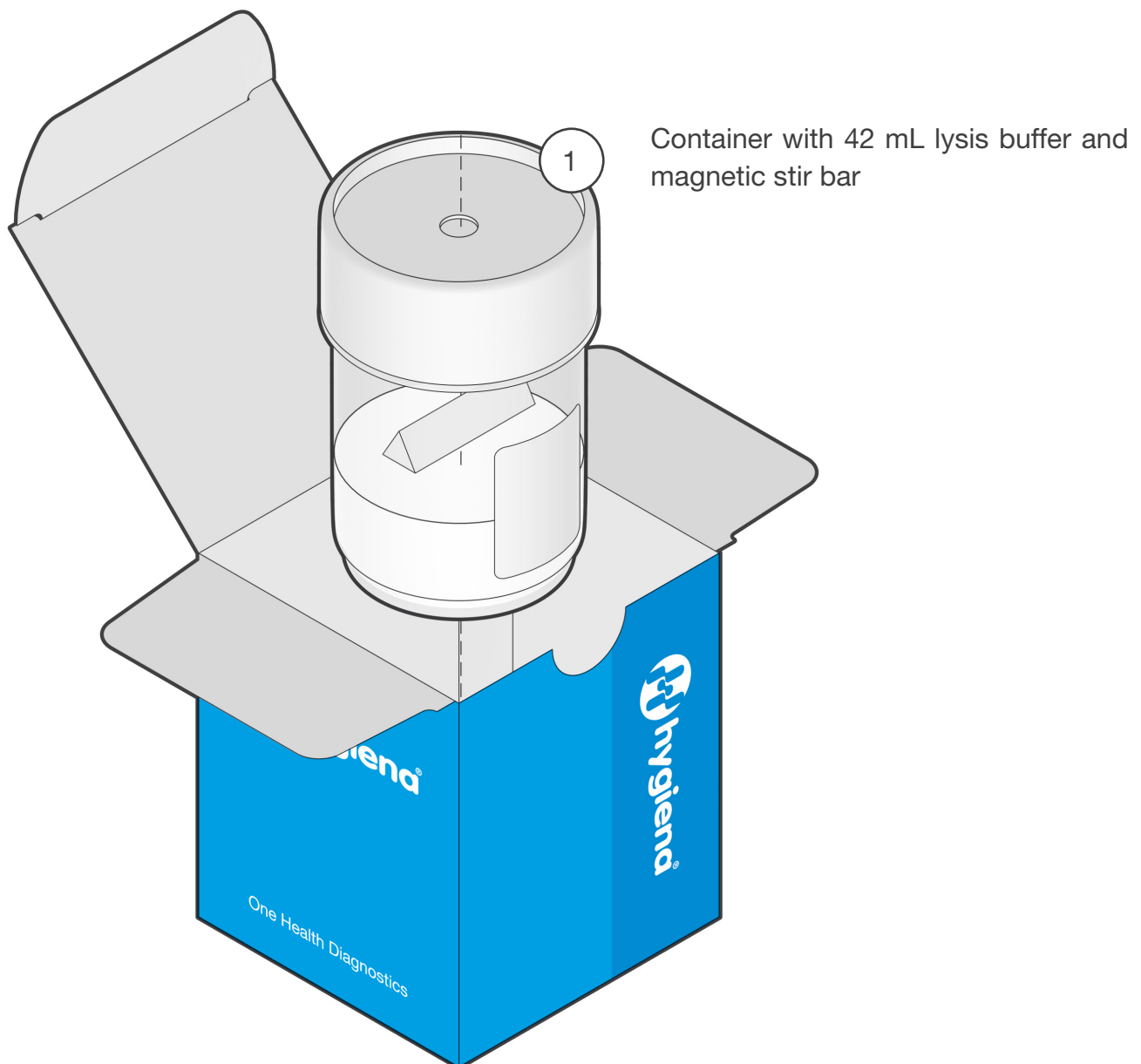

INSTRUCTIONS

2. INSTRUCTIONS

This section provides all relevant information for a seamless DNA extraction from a variety of matrices.

2.1 Required Material

Most of the required equipment and reagents are available from Hygiena®. Please contact us for further information.



It is highly recommended only to use the materials described below to guarantee the robustness of the method.

Reagents

Reagent D

Product No. KIT230001/02/03

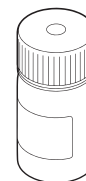

Sterile **sodium citrate** (Trisodium 2-hydroxypropane-1,2,3-tricarboxylate; CAS Number: 6132-04-3) **solution, 2% (w/v)**

Not provided by Hygiena

Only for Quantification Procedures (2.3.1)

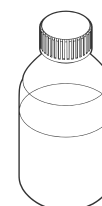

Buffered **sodium chloride peptone solution pH 7.0**

Not provided by Hygiena

Only for Qualitative Detection Procedures (2.3.2)

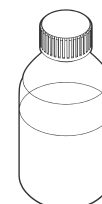

INSTRUCTIONS

Equipment

- Standard tabletop **microcentrifuge** capable of a 13,000 × g centrifugal force

e.g., Micro Star 17 - VWR

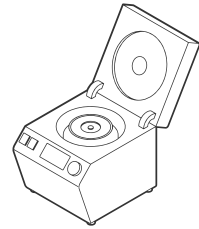

- Heating unit** suitable for 2 mL tubes

e.g., AccuBlock™ - Labnet with heating block

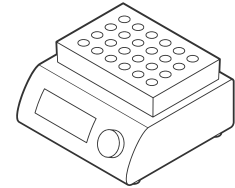

- Unit for **mechanical cell disruption** suitable for working with 2 mL reaction tubes

GeneReady - Hangzhou Lifereal Biotechnology
or

BeadBug™ - Benchmark Scientific

For other devices, please inquire (see 2.5. Support).

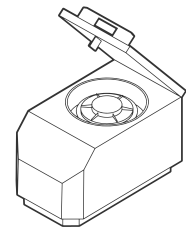

- Magnetic stirrer**

e.g., Color squid IKAMAG® - IKA®-Werke

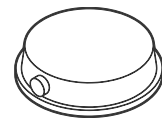

- Vortex mixer**

e.g., Vortex Genie - Scientific Industries

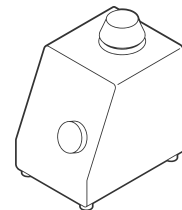

- D-Light**

Product No. MCH230039

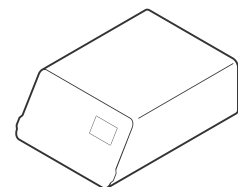

- Lab **homogenizer** / blender

e.g., BagMixer 400 W - Interscience

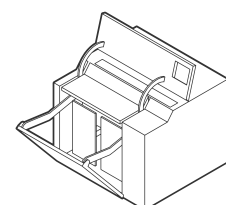

Only for Quantification Procedures (2.3.1)

INSTRUCTIONS

Consumables

- Sterile **2 mL reaction tubes with transparent screw caps**



- Blender bags with filter layer** (Pore size: 100 - 400 µm)

Only for Quantification Procedures (2.3.1)

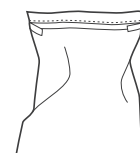

2.2 Precautions and Preparations

Follow all universal safety precautions governing work with biohazardous materials, e.g., wear lab coats and gloves at all times. Properly dispose of all contaminated materials, decontaminate work surfaces, and use a biosafety cabinet whenever aerosols might be generated.

For more information, please refer to the appropriate safety data sheet (SDS). The SDS is available online at www.hygiena.com/sds.

- Always use filter tips in order to avoid cross-contamination.

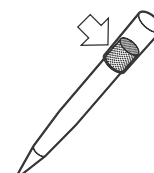

- Mix thoroughly while pipetting the buffer for sample preparation.

It is not recommended to use more than 96 reactions. The container must retain some of the reagent. Do not use anymore reagent once the minimum level mark on the container has been reached. The mark indicates the minimal allowed pipetting level while the stirrer is not in use.

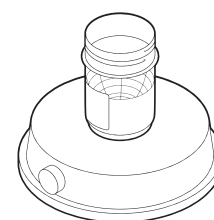

- Set the heating unit to 95 to 100 °C.

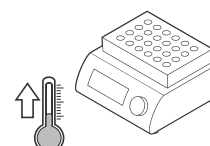

- Thaw Reagent D prior to use.

Avoid more than three freeze-thaw cycles. If necessary, aliquots can be prepared and stored according to the Reagent D manual. Avoid extended exposure to light.

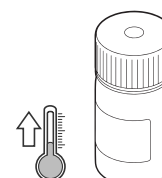

WORKFLOWS/QUANTIFICATION**2.3 Workflows**

Chapter 2.3.1 provides protocols for a quantitative analysis of all yeast and molds in different matrices within 5 hours and without an enrichment step.

Chapter 2.3.2 provides protocols for qualitative analysis of yeast and molds including an enrichment step.

2.3.1 Yeast and Mold - Quantification**Recommended Procedures for Different Matrices**

For preparation of genomic DNA from various samples for quantitative analysis, refer to the tables below and choose the appropriate procedure depending on your sample material.

Buffer solution:

SoCi: sodium citrate solution

SEAFOOD Samples	Quantification Procedure					
	A	B	C	D	E	Dilute Sample
Raw fish	-	+	-	-	-	1:10 (w/v) with SoCi, 2 % (w/v)
Minced fish	-	+	-	-	-	1:10 (w/v) with SoCi, 2 % (w/v)
Canned fish	-	+	-	-	-	1:10 (w/v) with SoCi, 2 % (w/v)
Acidified and marinated fish	-	+	-	-	-	1:10 (w/v) with SoCi, 2 % (w/v)
Fish salad	-	+	-	-	-	1:10 (w/v) with SoCi, 2 % (w/v)

CANNABIS Samples	Quantification Procedure					
	A	B	C	D	E	Dilute Sample
Edible gummy	-	+	-	-	-	1:10 (w/v) with SoCi, 2 % (w/v)
Flowers	-	+	-	-	-	1:100 (w/v) with SoCi, 2 % (w/v)
Wax	-	+	-	-	-	1:10 (w/v) with SoCi, 2 % (w/v)
White chocolate	-	+	-	-	-	1:10 (w/v) with SoCi, 2 % (w/v)

BEER Samples	Quantification Procedure					
	A	B	C	D	E	Dilute Sample
Hops	-	+	-	-	-	1:100 (w/v) with SoCi, 2 % (w/v)

QUANTIFICATION PROCEDURE

DAIRY Samples	Quantification Procedure					
	A	B	C	D	E	Dilute Sample
Butter	+	-	-	-	-	1:10 (w/v) with SoCi, 2 % (w/v)
Cream / whipped cream	+	+	-	-	-	1:10 (w/v) with SoCi, 2 % (w/v)
Condensed milk	+	+	+	-	-	1:10 (w/v) with SoCi, 2 % (w/v)
Milk	+	+	+	-	-	1:10 (w/v) with SoCi, 2 % (w/v)
Buttermilk	-	+	+	-	-	1:10 (w/v) with SoCi, 2 % (w/v)
Soured milk	-	+	+	-	-	1:10 (w/v) with SoCi, 2 % (w/v)
Sour cream	-	+	+	-	-	1:10 (w/v) with SoCi, 2 % (w/v)
Crème fraîche	-	+	+	-	-	1:10 (w/v) with SoCi, 2 % (w/v)
Mascarpone	-	+	+	-	-	1:10 (w/v) with SoCi, 2 % (w/v)
Yogurt	-	+	+	-	-	1:10 (w/v) with SoCi, 2 % (w/v)
Kefir	-	+	+	-	-	1:10 (w/v) with SoCi, 2 % (w/v)
Pudding	-	+	+	-	-	1:10 (w/v) with SoCi, 2 % (w/v)
Ice cream	-	+	+	-	-	1:10 (w/v) with SoCi, 2 % (w/v)
Semi-hard cheese	-	+	+	-	-	1:10 (w/v) with SoCi, 2 % (w/v)
Scalded cheese	-	+	+	-	-	1:10 (w/v) with SoCi, 2 % (w/v)
Cooked cheese	-	+	+	-	-	1:10 (w/v) with SoCi, 2 % (w/v)
Brine cheese	-	+	+	-	-	1:10 (w/v) with SoCi, 2 % (w/v)
Skim milk powder	-	+	+	-	-	1:10 (w/v) with SoCi, 2 % (w/v)
Infant formula	-	+	+	-	-	1:10 (w/v) with SoCi, 2 % (w/v)
Whey	-	-	+	-	-	1:10 (w/v) with SoCi, 2 % (w/v)
Whey powder	-	-	+	-	-	1:10 (w/v) with SoCi, 2 % (w/v)
Unskimmed milk powder	-	-	+	+	-	1:10 (w/v) with SoCi, 2 % (w/v)
Spray cream powder	-	-	+	+	-	1:10 (w/v) with SoCi, 2 % (w/v)
Soft cheese	-	-	+	+	-	1:10 (w/v) with SoCi, 2 % (w/v)
Curd / curd cheese	-	-	-	+	-	1:10 (w/v) with SoCi, 2 % (w/v)
Yoghurt powder	-	-	-	-	+	1:10 (w/v) with SoCi, 2 % (w/v)
Curd powder	-	-	-	-	+	1:10 (w/v) with SoCi, 2 % (w/v)

EXTRACTION PROCEDURE A

YEAST AND MOLD - QUANTIFICATION

2.3.1.1 EXTRACTION PROCEDURE A

This protocol is recommended for samples like butter and cream. A step for live and dead cell differentiation with Reagent D is included.

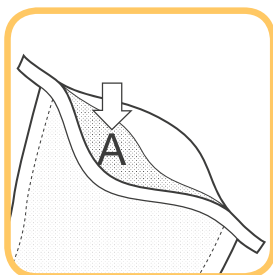

1. SUSPEND SAMPLE

Dilute sample with **buffer solution** (for details see tables 2.3.1) in a suitable blender bag with filter layer.

Note: Weigh the sample in one side (A) of the blender bag with filter layer.



2. HOMOGENIZE SAMPLE

Homogenize for **60 s at maximum speed** in a homogenization unit. Let the suspension settle for 5 to 10 min.

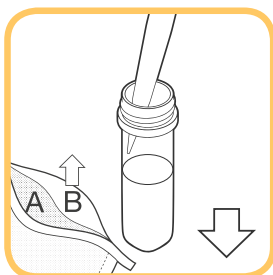

3. ADD SAMPLE

Transfer **up to 1,000 µL** sample (supernatant) to a transparent 2 mL reaction tube with transparent screw cap.

Note: Use the supernatant from the other side (B) of the blender bag.

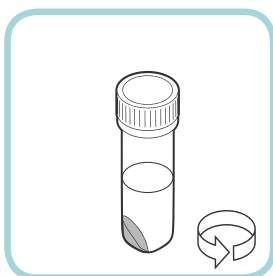

4. CENTRIFUGE

5 min at 13,000 x g.

Note: If necessary, centrifugation forces should be calculated according to the manual of the used centrifuge.

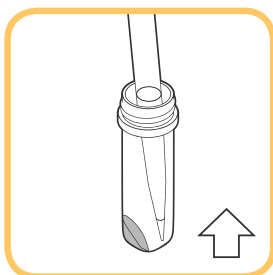

5. REMOVE SUPERNATANT

Completely discard liquid with a pipette immediately after centrifugation and inactivate appropriately.

Note: Take care that the tip of the pipette is on the opposite side of the pellet during pipetting.

EXTRACTION PROCEDURE A

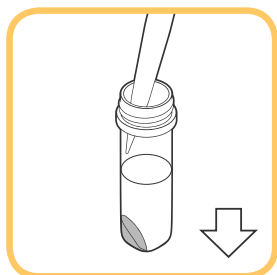

6. ADD REAGENT D

Transfer **300 µL** Reagent D and resuspend the pellet by pipetting gently up and down 5 to 10 times.

Note: Proceed immediately with the following steps of the protocol. Avoid extended exposure to light.

For optimal efficiency, the pellet has to be completely resuspended.

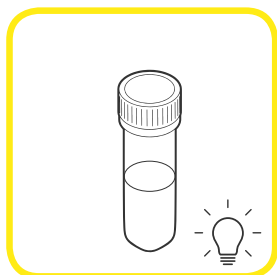

7. D-LIGHT TREATMENT

Incubate for **10 min at room temperature** in the D-Light **in the dark**.

Incubate for **5 min at room temperature** in the D-Light **with light exposure**.

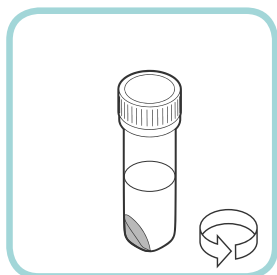

8. CENTRIFUGE

5 min at 13,000 x g.

Note: If necessary, centrifugation forces should be calculated according to the centrifuge users manual.

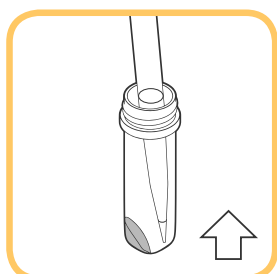

9. REMOVE SUPERNATANT

Completely discard liquid with a pipette immediately after centrifugation and inactivate appropriately.

Note: Take care that the tip of the pipette is on the opposite side of the pellet during pipetting.

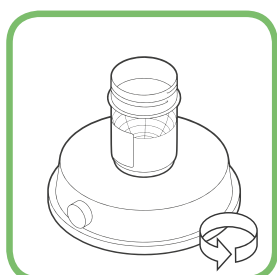

10. PREPARE LYSIS BUFFER

Place closed lysis buffer container on the magnetic stirrer.

Continuously mix lysis buffer at 400 rpm on the magnetic stirrer to keep solution homogeneous.

Open the lysis buffer container.

Note: Hold the container while switching on the magnetic stirrer and during pipetting.

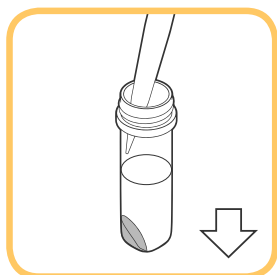

11. ADD LYSIS BUFFER

Transfer **300 µL** lysis buffer to the tube with the sample pellet.

Note: Pipet carefully and vertically along the lysis buffer container wall, approximately 0.5 cm above the bottom.

Use a 1,000 µL filter tip to transfer lysis buffer to the sample.

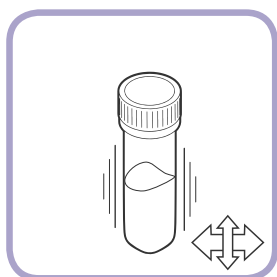
EXTRACTION PROCEDURE A**12. MECHANICAL DISRUPTION**

Place tube in a cell disruption unit and perform disruption:

GeneReady - 4 min at 6.5 m/s or

BeadBug - 2 min at 4,000 rpm

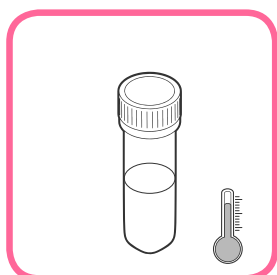
**13. INCUBATE**

5 min at 95 to 100 °C in a heating unit.

Carefully remove the reaction tube from the heating unit and allow the tube to sit for **1 min at 15 to 25 °C**.

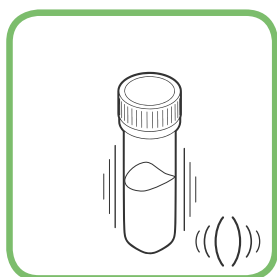
**14. MIX**

Vortex for 2 sec.

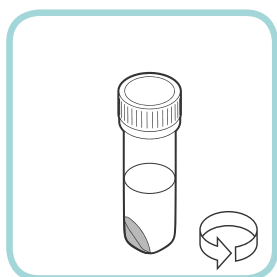
**15. CENTRIFUGE**

5 min at 13,000 x g.

Note: If necessary, centrifugation forces should be calculated according to the manual for the centrifuge used.

SUPERNATANT FOR DETECTION

Use 25 µL of extract for the foodproof Yeast and Mold Quantification LyoKit.

Strictly avoid transferring fractions of the sediment to the PCR reaction, because this might cause PCR inhibition.

For later analysis, store DNA at -15 to -25 °C.

After thawing, mix briefly by vortexing and centrifuge at 13,000 x g for 2 min.

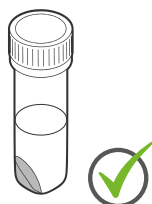

EXTRACTION PROCEDURE B

YEAST AND MOLD - QUANTIFICATION

2.3.1.2 EXTRACTION PROCEDURE B

This fast protocol is recommended for samples like milk, soured milk, yogurt, cheese and skim milk powder. A step for live and dead cell differentiation with Reagent D is included.

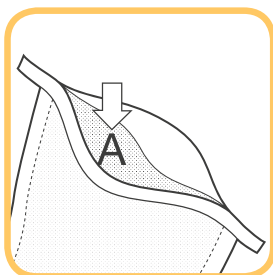

1. SUSPEND SAMPLE

Dilute sample with **buffer solution** (for details see tables 2.3.1) in a suitable blender bag with filter layer.

Note: Weigh the sample in one side (A) of the blender bag with filter layer.

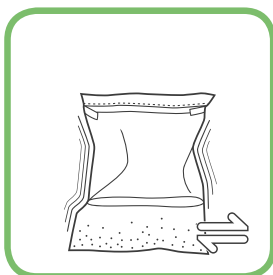

2. HOMOGENIZE SAMPLE

Homogenize for **60 s at maximum speed** in a homogenization unit. Let the suspension settle for 5 to 10 min.

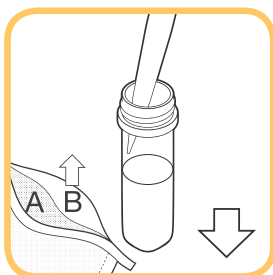

3. ADD SAMPLE

Transfer **up to 500 µL** sample (supernatant) to a transparent 2 mL reaction tube with transparent screw cap.

Note: Use the supernatant from the other side (B) of the blender bag.

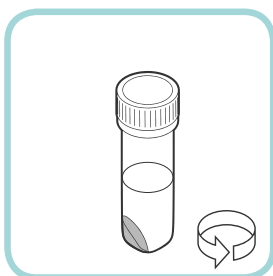

4. CENTRIFUGE

5 min at 13,000 x g.

Note: If necessary, centrifugation forces should be calculated according to the centrifuge users manual.

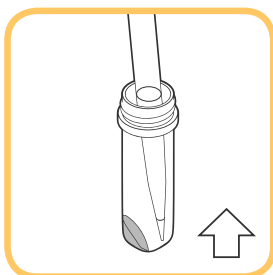

5. REMOVE SUPERNATANT

Completely discard liquid with a pipette immediately after centrifugation and inactivate appropriately.

Note: Take care that the tip of the pipette is on the opposite side of the pellet during pipetting.

EXTRACTION PROCEDURE B

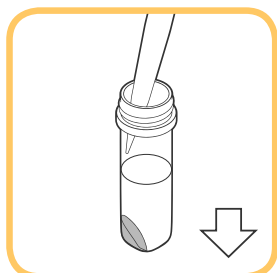

6. ADD REAGENT D

Transfer **300 µL** Reagent D and resuspend the pellet by pipetting gently up and down 5 to 10 times.

Note: Proceed immediately with the following steps of the protocol. Avoid extended exposure to light.

For optimal efficiency, the pellet has to be completely resuspended.

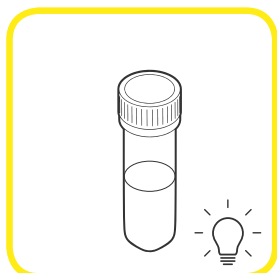

7. D-LIGHT TREATMENT

Incubate for **10 min at room temperature** in the D-Light **in the dark**, Incubate for **5 min at room temperature** in the D-Light **with light exposure**.

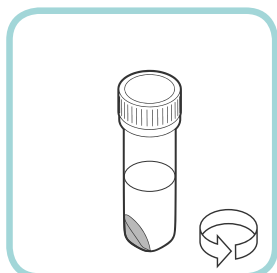

8. CENTRIFUGE

5 min at 13,000 x g.

Note: If necessary, centrifugation forces should be calculated according to the manual of the used centrifuge.

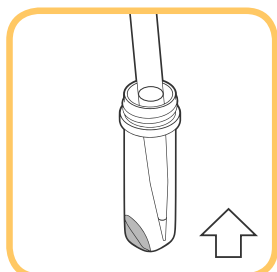

9. REMOVE SUPERNATANT

Completely discard liquid with a pipette immediately after centrifugation and inactivate appropriately.

Note: Take care that the tip of the pipette is on the opposite side of the pellet during pipetting.

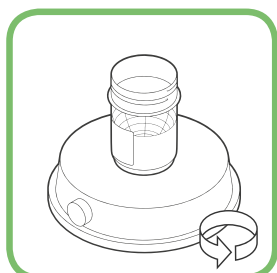

10. PREPARE LYSIS BUFFER

Place closed lysis buffer container on the magnetic stirrer.

Continuously mix lysis buffer at 400 rpm on the magnetic stirrer to keep solution homogeneous.

Open the lysis buffer container.

Note: Hold the container while switching on the magnetic stirrer and during pipetting.

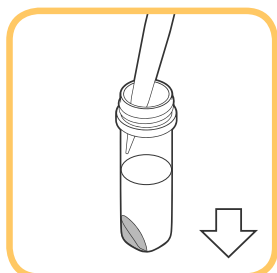

11. ADD LYSIS BUFFER

Transfer **300 µL** lysis buffer to the tube with the sample pellet.

Note: Pipet carefully and vertically along the lysis buffer container wall, approximately 0.5 cm above the bottom.

Use a 1,000 µL filter tip to transfer lysis buffer to the sample.

EXTRACTION PROCEDURE B

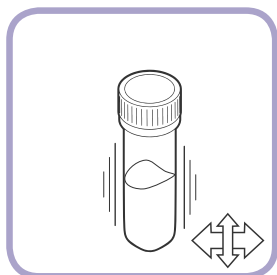

12. MECHANICAL DISRUPTION

Place tube in a cell disruption unit and perform disruption:

GeneReady - 4 min at 6.5 m/s or

BeadBug - 2 min at 4,000 rpm

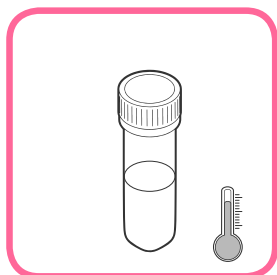

13. INCUBATE

5 min at 95 to 100 °C in a heating unit.

Carefully remove the reaction tube from the heating unit and allow the tube to sit for **1 min at 15 to 25 °C**.

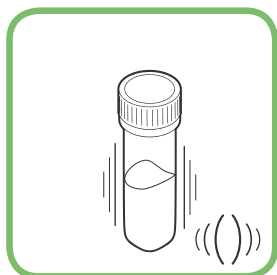

14. MIX

Vortex for 2 sec.

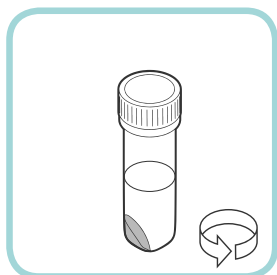

15. CENTRIFUGE

5 min at 13,000 x g.

Note: If necessary, centrifugation forces should be calculated according to the manual for the centrifuge used.

SUPERNATANT FOR DETECTION

Use 25 µL of extract for the foodproof Yeast and Mold Quantification LyoKit.

Strictly avoid transferring fractions of the sediment to the PCR reaction, because this might cause PCR inhibition.

For later analysis, store DNA at -15 to -25 °C.

After thawing, mix briefly by vortexing and centrifuge at 13,000 x g for 2 min.

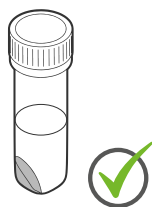

EXTRACTION PROCEDURE C**YEAST AND MOLD - QUANTIFICATION**
2.3.1.3 EXTRACTION PROCEDURE C

This protocol is recommended for samples like whey, whey powder, unskimmed milk powder and cream powder. A step for live and dead cell differentiation with Reagent D and an extended heating step are included.

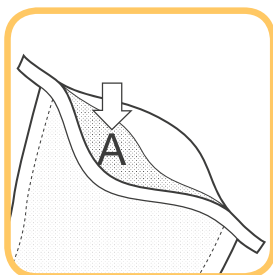
**1. SUSPEND SAMPLE**

Dilute sample with buffer solution (for details see tables 2.3.1) in a suitable blender bag with filter layer.

Note: Weigh the sample in one side (A) of the blender bag with filter layer.

**2. HOMOGENIZE SAMPLE**

Homogenize for **60 s at maximum speed** in a homogenization unit. Let the suspension settle for 5 to 10 min.

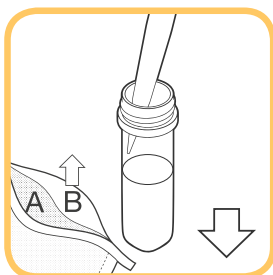
**3. ADD SAMPLE**

Transfer **up to 500 µL** sample (supernatant) to a transparent 2 mL reaction tube with transparent screw cap.

Note: Use the supernatant from the other side (B) of the blender bag.

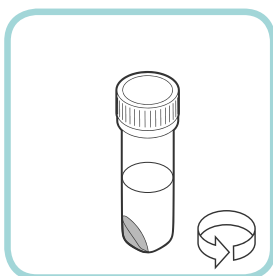
**4. CENTRIFUGE**

5 min at 13,000 x g.

Note: If necessary, centrifugation forces should be calculated according to the centrifuge users manual.

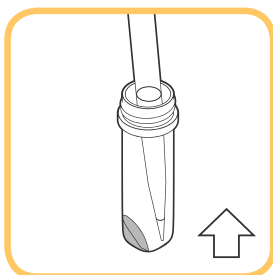
**5. REMOVE SUPERNATANT**

Completely discard liquid with a pipette immediately after centrifugation and inactivate appropriately.

Note: Take care that the tip of the pipette is on the opposite side of the pellet during pipetting.

EXTRACTION PROCEDURE C

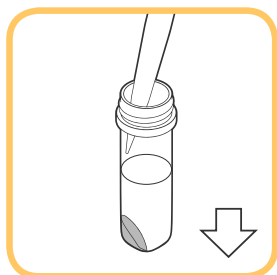

6. ADD REAGENT D

Transfer **300 µL** Reagent D and resuspend the pellet by pipetting gently up and down 5 to 10 times.

Note: Proceed immediately with the following steps of the protocol. Avoid extended exposure to light.

For optimal efficiency, the pellet has to be completely resuspended.

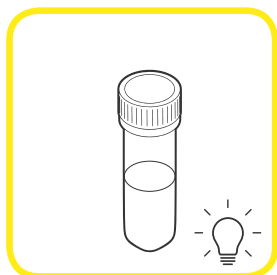

7. D-LIGHT TREATMENT

Incubate for **10 min at room temperature** in the D-Light **in the dark**, Incubate for **5 min at room temperature** in the D-Light **with light exposure**.

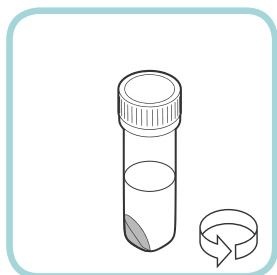

8. CENTRIFUGE

5 min at 13,000 x g.

Note: If necessary, centrifugation forces should be calculated according to the centrifuge users manual.

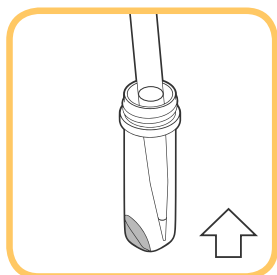

9. REMOVE SUPERNATANT

Completely discard liquid with a pipette immediately after centrifugation and inactivate appropriately.

Note: Take care that the tip of the pipette is on the opposite side of the pellet during pipetting.

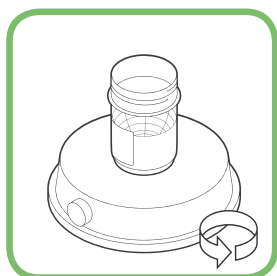

10. PREPARE LYSIS BUFFER

Place closed lysis buffer container on the magnetic stirrer.

Continuously mix lysis buffer at 400 rpm on the magnetic stirrer to keep solution homogeneous.

Open the lysis buffer container.

Note: Hold the container while switching on the magnetic stirrer and during pipetting.

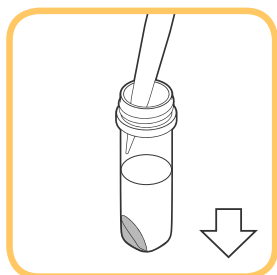

11. ADD LYSIS BUFFER

Transfer **300 µL** lysis buffer to the tube with the sample pellet.

Note: Pipet carefully and vertically along the lysis buffer container wall, approximately 0.5 cm above the bottom.

Use a 1,000 µL filter tip to transfer lysis buffer to the sample.

EXTRACTION PROCEDURE C

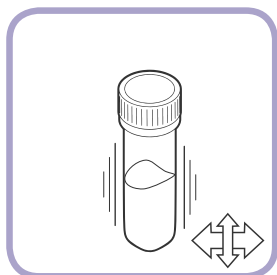

12. MECHANICAL DISRUPTION

Place tube in a cell disruption unit and perform disruption:

GeneReady - 4 min at 6.5 m/s or

BeadBug - 2 min at 4,000 rpm

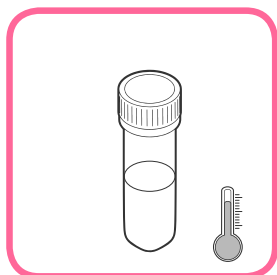

13. INCUBATE

30 min at 95 to 100 °C in a heating unit.

Carefully remove the reaction tube from the heating unit and allow the tube to sit for **1 min at 15 to 25 °C**.



14. MIX

Vortex for 2 sec.

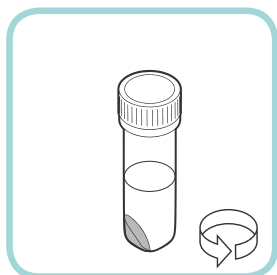

15. CENTRIFUGE

5 min at 13,000 x g.

Note: If necessary, centrifugation forces should be calculated according to the manual for the centrifuge used.

SUPERNATANT FOR DETECTION

Use 25 µL of extract for the foodproof Yeast and Mold Quantification LyoKit.

Strictly avoid transferring fractions of the sediment to the PCR reaction, because this might cause PCR inhibition.

For later analysis, store DNA at -15 to -25 °C.

After thawing, mix briefly by vortexing and centrifuge at 13,000 x g for 2 min.

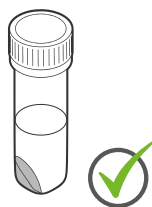

EXTRACTION PROCEDURE D

YEAST AND MOLD - QUANTIFICATION 2.3.1.4 EXTRACTION PROCEDURE D

This protocol is recommended for samples like curd and curd cheese. A step for live and dead cell differentiation with Reagent D, an additional wash step with sodium citrate solution and extended heating are included.

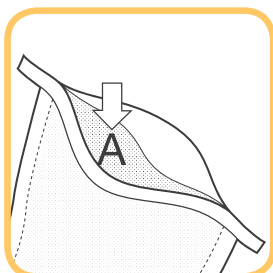

1. SUSPEND SAMPLE

Dilute sample with buffer solution (for details see tables 2.3.1) in a suitable blender bag with filter layer.

Note: Weigh the sample in one side (A) of the blender bag with filter layer.

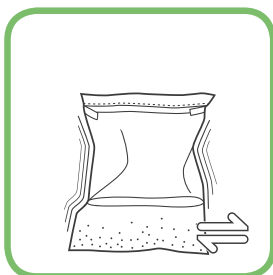

2. HOMOGENIZE SAMPLE

Homogenize for **60 s at maximum speed** in a homogenization unit. Let the suspension settle for 5 to 10 min.

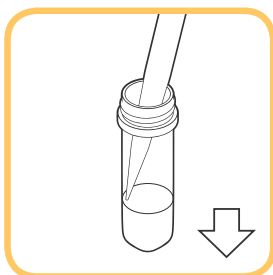

3. ADD SODIUM CITRATE TO A NEW TUBE

Transfer **up to 500 µL** sodium citrate solution, 2 % (w/v), to a transparent 2 mL reaction tube with transparent screw cap.

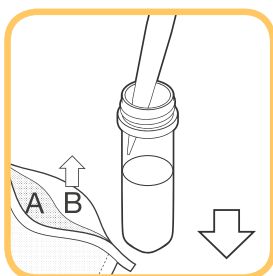

4. ADD SAMPLE

Transfer **up to 500 µL** sample (supernatant).

Note: Use the supernatant from the other side (B) of the blender bag.

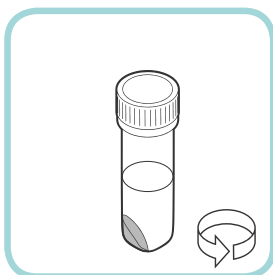

5. CENTRIFUGE

5 min at 13,000 x g.

Note: If necessary, centrifugation forces should be calculated according to the centrifuge users manual.

EXTRACTION PROCEDURE D

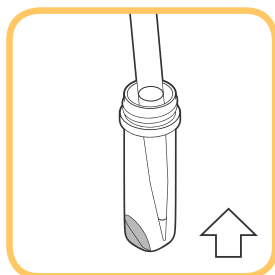

6. REMOVE SUPERNATANT

Completely discard liquid with a pipette immediately after centrifugation and inactivate appropriately.

Note: Take care that the tip of the pipette is on the opposite side of the pellet during pipetting.

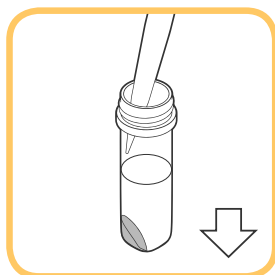

7. ADD REAGENT D

Transfer **300 µL** Reagent D and resuspend the pellet by pipetting gently up and down 5 to 10 times.

Note: Proceed immediately with the following steps of the protocol. Avoid extended exposure to light.

For optimal efficiency, the pellet has to be completely resuspended.

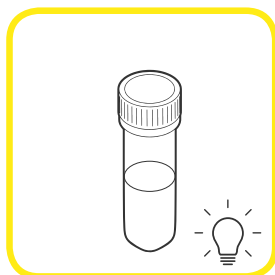

8. D-LIGHT TREATMENT

Incubate for **10 min at room temperature** in the D-Light **in the dark**,
Incubate for **5 min at room temperature** in the D-Light **with light exposure**.

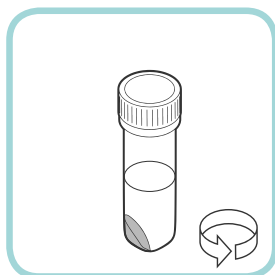

9. CENTRIFUGE

5 min at 13,000 x g.

Note: If necessary, centrifugation forces should be calculated according to the centrifuge users manual.

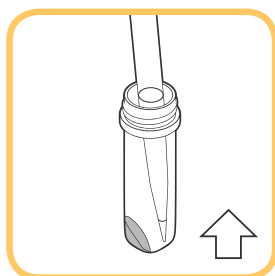

10. REMOVE SUPERNATANT

Completely discard liquid with a pipette immediately after centrifugation and inactivate appropriately.

Note: Take care that the tip of the pipette is on the opposite side of the pellet during pipetting.

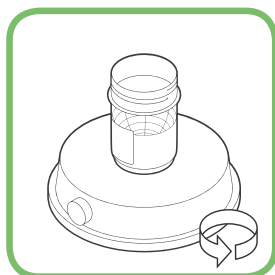

11. PREPARE LYSIS BUFFER

Place closed lysis buffer container on the magnetic stirrer.

Continuously mix lysis buffer at 400 rpm on the magnetic stirrer to keep solution homogeneous.

Open the lysis buffer container.

Note: Hold the container while switching on the magnetic stirrer and during pipetting.

EXTRACTION PROCEDURE D

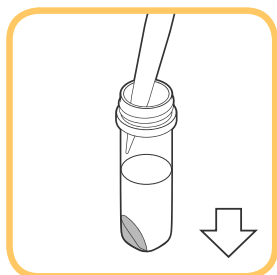
**12. ADD LYSIS BUFFER**

Transfer **300 µL** lysis buffer to the tube with the sample pellet.

Note: Pipet carefully and vertically along the lysis buffer container wall, approximately 0.5 cm above the bottom.

Use a 1,000 µL filter tip to transfer lysis buffer to the sample.

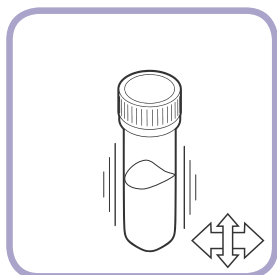
**13. MECHANICAL DISRUPTION**

Place tube in a cell disruption unit and perform disruption:

GeneReady - 4 min at 6.5 m/s or

BeadBug - 2 min at 4,000 rpm

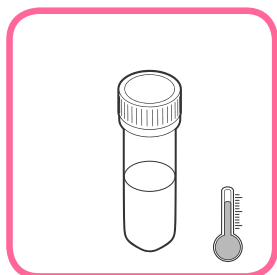
**14. INCUBATE**

30 min at 95 to 100 °C in a heating unit.

Carefully remove the reaction tube from the heating unit and allow the tube to sit for **1 min at 15 to 25 °C**.

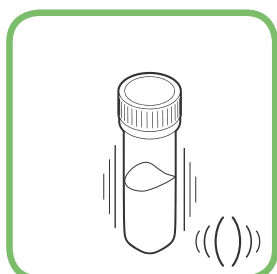
**15. MIX**

Vortex for 2 sec.

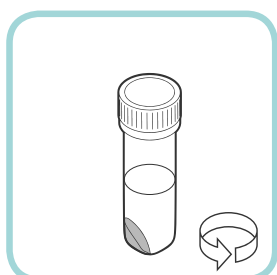
**16. CENTRIFUGE**

5 min at 13,000 x g.

Note: If necessary, centrifugation forces should be calculated according to the manual for the centrifuge used.

SUPERNATANT FOR DETECTION

Use 25 µL of extract for the foodproof Yeast and Mold Quantification LyoKit.

Strictly avoid transferring fractions of the sediment to the PCR reaction, because this might cause PCR inhibition.

For later analysis, store DNA at -15 to -25 °C.

After thawing, mix briefly by vortexing and centrifuge at 13,000 x g for 2 min.

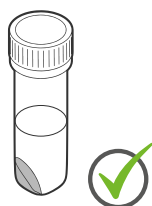

EXTRACTION PROCEDURE E

YEAST AND MOLD - QUANTIFICATION

2.3.1.5 EXTRACTION PROCEDURE E

This protocol is recommended for samples like yogurt powder and curd powder. A step for live and dead cell differentiation with Reagent D, an additional centrifugation step, a wash step with sodium citrate solution and extended heating are included.

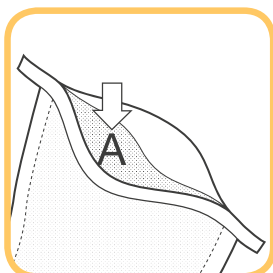

1. SUSPEND SAMPLE

Dilute sample with buffer solution (for details see tables 2.3.1) in a suitable blender bag with filter layer.

Note: Weigh the sample in one side (A) of the blender bag with filter layer.

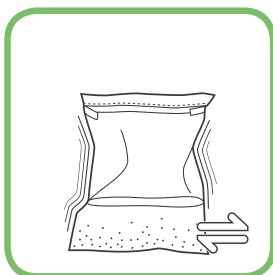

2. HOMOGENIZE SAMPLE

Homogenize for **60 s at maximum speed** in a homogenization unit. Let the suspension settle for 5 to 10 min.

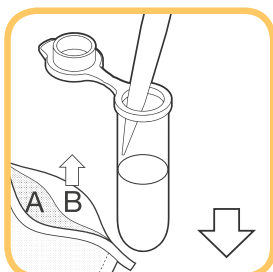

3. ADD SAMPLE

Transfer **up to 1,500 µL** sample (supernatant) to a 2 mL reaction tube.

Note: Use the supernatant from the other side (B) of the blender bag.

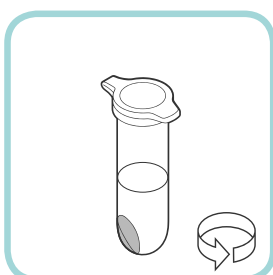

4. CENTRIFUGE

1 min at low speed: 100 x g.

Note: If necessary, centrifugation forces should be calculated according to the centrifuge user manual.

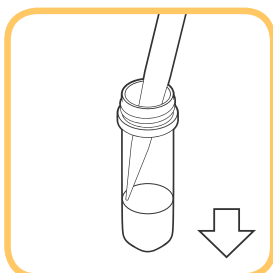

5. ADD SODIUM CITRATE TO A NEW TUBE

Transfer **up to 500 µL** sodium citrate solution, 2 % (w/v), to a transparent 2 mL reaction tube with transparent screw cap.

EXTRACTION PROCEDURE E

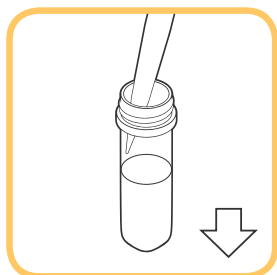

6. ADD SAMPLE

Transfer **up to 500 µL** sample (supernatant step 4) and mix by pipetting gently up and down 5 to 10 times.

Note: Parts of the sediment from step 4 may inhibit PCR and must not be used.

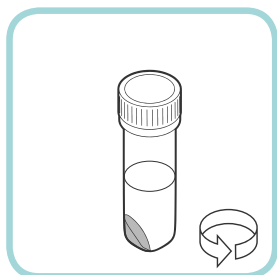

7. CENTRIFUGE

5 min at 13,000 x g.

Note: If necessary, centrifugation forces should be calculated according to the centrifuge user manual.

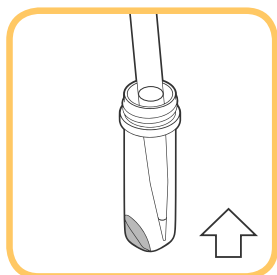

8. REMOVE SUPERNATANT

Completely discard liquid with a pipette immediately after centrifugation and inactivate appropriately.

Note: Take care that the tip of the pipette is on the opposite side of the pellet during pipetting.

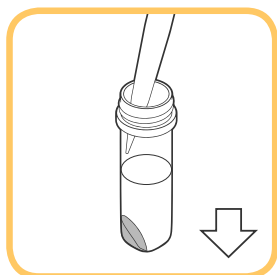

9. ADD REAGENT D

Transfer **300 µL** Reagent D and resuspend the pellet by pipetting gently up and down 5 to 10 times.

Note: Proceed immediately with the following steps of the protocol. Avoid extended exposure to light. For optimal efficiency, the pellet has to be completely resuspended.

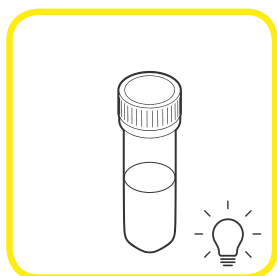

10. D-LIGHT TREATMENT

Incubate for **10 min at room temperature** in the D-Light **in the dark**, Incubate for **5 min at room temperature** in the D-Light **with light exposure**.

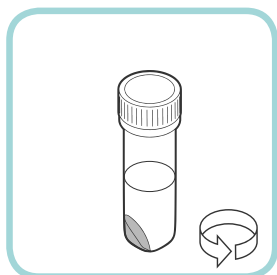

11. CENTRIFUGE

5 min at 13,000 x g.

Note: If necessary, centrifugation forces should be calculated according to the centrifuge users manual.

EXTRACTION PROCEDURE E

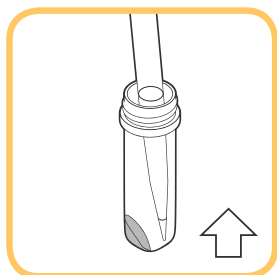

12. REMOVE SUPERNATANT

Completely discard liquid with a pipette immediately after centrifugation and inactivate appropriately.

Note: Take care that the tip of the pipette is on the opposite side of the pellet during pipetting.

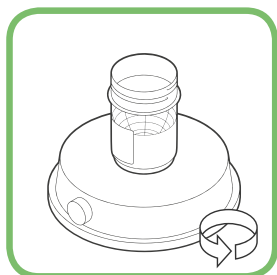

13. PREPARE LYSIS BUFFER

Place closed lysis buffer container on the magnetic stirrer.

Continuously mix lysis buffer at 400 rpm on the magnetic stirrer to keep solution homogeneous.

Open the lysis buffer container.

Note: Hold the container while switching on the magnetic stirrer and during pipetting.

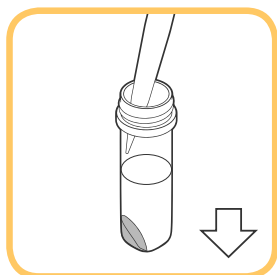

14. ADD LYSIS BUFFER

Transfer **300 µL** lysis buffer to the tube with the sample pellet.

Note: Pipet carefully and vertically along the lysis buffer container wall, approximately 0.5 cm above the bottom.

Use a 1,000 µL filter tip to transfer lysis buffer to the sample.

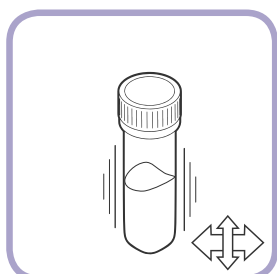

15. MECHANICAL DISRUPTION

Place tube in a cell disruption unit and perform disruption:

GeneReady - 4 min at 6.5 m/s or

BeadBug - 2 min at 4,000 rpm

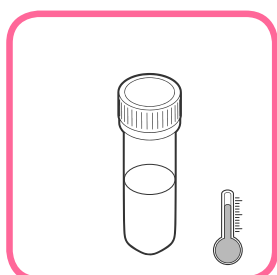

16. INCUBATE

30 min at 95 to 100 °C in a heating unit.

Carefully remove the reaction tube from the heating unit and allow the tube to sit for **1 min at 15 to 25 °C**.



17. MIX

Vortex for 2 sec.



18. CENTRIFUGE

5 min at 13,000 x g.

Note: If necessary, centrifugation forces should be calculated according to the manual for the centrifuge used.



SUPERNATANT FOR DETECTION

Use 25 µL of extract for the foodproof Yeast and Mold Quantification LyoKit.

Strictly avoid transferring fractions of the sediment to the PCR reaction, because this might cause PCR inhibition.

For later analysis, store DNA at -15 to -25 °C.

After thawing, mix briefly by vortexing and centrifuge at 13,000 x g for 2 min.

QUALITATIVE DETECTION**2.3.2 Yeast and Mold - Qualitative Detection**

Recommended Procedures for Different Food Categories

For preparation of genomic DNA from various samples for qualitative analysis, refer to the table below.

DAIRY Samples	Procedure F
Chocolate milk	+

EXTRACTION PROCEDURE F**YEAST AND MOLD - QUALITATIVE DETECTION**
2.3.2.1 EXTRACTION PROCEDURE F

This fast protocol is recommended for enriched samples. A step for live and dead cell differentiation with Reagent D is included.

**1. SHAKE SAMPLE**

Shake enrichment culture gently and let the suspension settle for 5 to 10 min.

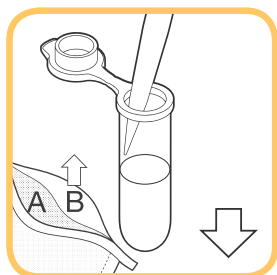
**2. ADD SAMPLE**

Transfer **150 µL** sample (supernatant) to a 2 mL reaction tube.

Note: Use the supernatant from the other side (B) of the blender bag.

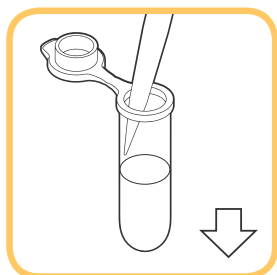
**3. SUSPEND SAMPLE**

Dilute sample **1:10 (w/v)** with **1,350 µL buffered sodium chloride peptone solution pH 7.0**.

Let suspension settle for 3 to 5 min.

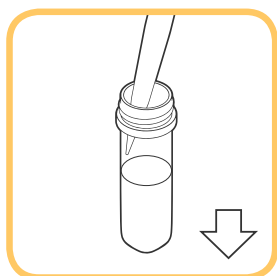
**4. ADD SUPERNATANT TO A NEW TUBE**

Transfer **500 µL** supernatant to a new 2 mL transparent reaction tube with transparent screw cap.

Note: Parts of the sediment may inhibit PCR and must not be used.

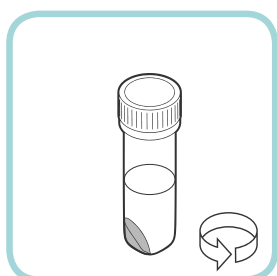
**5. CENTRIFUGE**

5 min at 13,000 x g.

Note: If necessary, centrifugation forces should be calculated according to the centrifuge user manual.

EXTRACTION PROCEDURE F

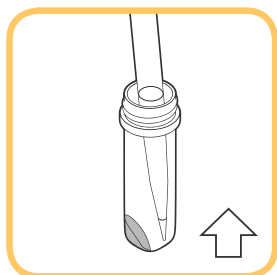

6. REMOVE SUPERNATANT

Completely discard liquid with a pipette immediately after centrifugation and inactivate appropriately.

Note: take care that the tip of the pipette is on the opposite side of the pellet during pipetting.

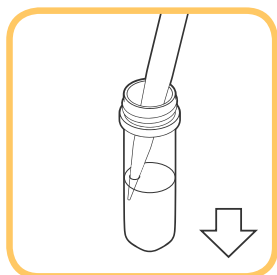

7. ADD REAGENT D

Transfer **300 µL** Reagent D and resuspend the pellet by pipetting gently up and down 5 to 10 times.

Note: Proceed immediately with the following steps of the protocol. Avoid extended exposure to light.

For optimal efficiency, the pellet has to be completely resuspended.

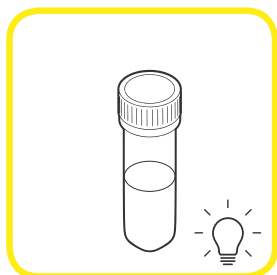

8. D-LIGHT TREATMENT

Incubate for **10 min at room temperature** in the D-Light **in the dark**,
Incubate for **5 min at room temperature** in the D-Light **with light exposure**.

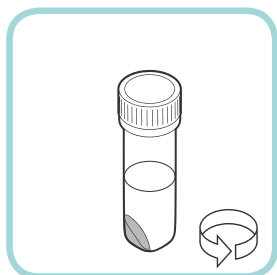

9. CENTRIFUGE

5 min at 13,000 x g.

Note: If necessary, centrifugation forces should be calculated according to the centrifuge user manual.

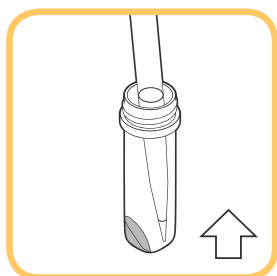

10. REMOVE SUPERNATANT

Completely discard liquid with a pipette immediately after centrifugation and inactivate appropriately.

Note: Take care that the tip of the pipette is on the opposite side of the pellet during pipetting.

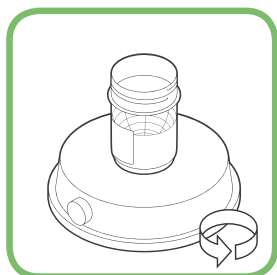

11. PREPARE LYSIS BUFFER

Place closed lysis buffer container on the magnetic stirrer.

Continuously mix lysis buffer at 400 rpm on the magnetic stirrer to keep solution homogeneous.

Open the lysis buffer container.

Note: hold the container while switching on the magnetic stirrer and during pipetting.

EXTRACTION PROCEDURE F

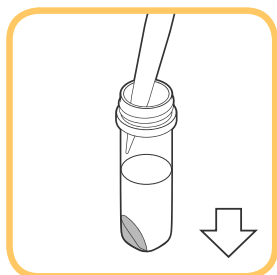

12. ADD LYSIS BUFFER

Transfer **300 µL** lysis buffer to the tube with the sample pellet.

Note: Pipet carefully and vertically along the lysis buffer container wall, approximately 0.5 cm above the bottom.

Use a 1,000 µL filter tip to transfer lysis buffer to the sample.

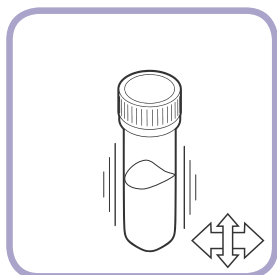

13. MECHANICAL DISRUPTION

Place tube in a cell disruption unit and perform disruption:

GeneReady - 4 min at 6.5 m/s or

BeadBug - 2 min at 4,000 rpm

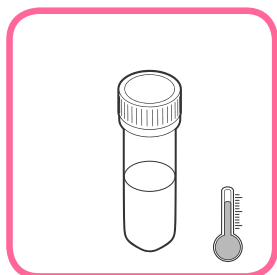

14. INCUBATE

5 min at 95 to 100 °C in a heating unit.

Carefully remove the reaction tube from the heating unit and allow the tube to sit for **1 min at 15 to 25 °C**.

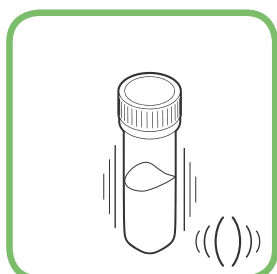

15. MIX

Vortex for 2 sec.

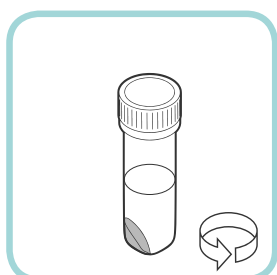

16. CENTRIFUGE

5 min at 13,000 x g.

Note: If necessary, centrifugation forces should be calculated according to the centrifuge user manual.

SUPERNATANT FOR DETECTION

Use 25 µL of extract for the foodproof Yeast and Mold Quantification LyoKit.

Strictly avoid transferring fractions of the sediment to the PCR reaction, because this might cause PCR inhibition.

For later analysis, store DNA at -15 to -25 °C.

After thawing, mix briefly by vortexing and centrifuge at 13,000 x g for 2 min.

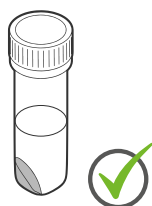

TROUBLESHOOTING

2.4 Troubleshooting

Problem	Possible Cause	Recommendation
Extract inhibits PCR	DNA extract contains too many PCR inhibitors.	Dilute DNA extract, e.g., 1:10, or reduce the amount of extracted DNA, e.g., for LyoKits 5 µL instead of 25 µL.
	Some of the centrifugation pellet transferred over to the PCR.	Always centrifuge the DNA sample before performing PCR. Use the top of the supernatant as a PCR template. Do not allow the filter tip to have contact with the pellet.
	Supernatants are not completely removed.	Remove supernatants completely (e.g., after Reagent D treatment).
Low DNA yield	Improper storage of kit components.	Store kit reagents at 15 to 25 °C.
	Sample contains substances that reduce the DNA extraction efficiency.	Reduce the sample volume.
	Pellet resuspension incomplete.	Improve resuspension by prolonged pipetting or vortexing.
	No or insufficient beads in the reaction (StarPrep Two, S 400 08.1).	Use correct stirring settings. Do not pipette more than 96 reactions. Do not use reagent below the minimal level indicated
	Suboptimal reaction conditions.	Ensure proper disruption and heating conditions. Verify correct temperature of the heating block with a thermometer.
Lid of the reaction tube opens during or after heating	Reaction tube not firmly closed.	Ensure that all reaction tubes are firmly closed before heating. Use lid clips for closing the tubes properly. Use a heating unit that enables removal of the tubes without directly touching the tube lids.

2.5 Support

If you have questions or experience any problems with our products, please contact us:



www.hygiena.com/support

Our aim is to provide you with a solution as quickly and effectively as possible. We would also like you to contact us if you have any suggestions for improving the product or in case you would like to use our product for a different application. We highly value your feedback.

ADDITIONAL INFORMATION

3. ADDITIONAL INFORMATION

3.1 General Information

Quality Control

All products are regularly monitored by our quality control. You can find the certificate of analysis (COA) on our website. If you would like to carry out your own quality control, you will find the analysis method described in the certificate.

Waste Disposal

All contaminated and potentially infectious material, like enrichment cultures or food samples, should be autoclaved before disposal and eliminated according to local rules and regulations. For proper disposal of unused chemicals, please refer to the SDS.

Warranty and Disclaimer of Liability

“Limited Warranty” and “Disclaimer of Liability”: Hygiena Diagnostics GmbH warrants that this product is free from defects in materials and workmanship through the expiration date printed on the label and only if the following are complied with:

- (1) The product is used according to the guidelines and instructions set forth in the product literature;
- (2) Hygiena Diagnostics GmbH does not warrant its product against any and all defects when: the defect is as a result of material or workmanship not provided by Hygiena Diagnostics GmbH; defects caused by misuse or use contrary to the instructions supplied, or improper storage or handling of the product;
- (3) All warranties of merchantability and fitness for a particular purpose, written, oral, expressed or implied, shall extend only for a period of one year from the date of manufacture. There are no other warranties that extend beyond those described on the face of this warranty;
- (4) Hygiena Diagnostics GmbH does not undertake responsibility to any purchaser of its product for any undertaking, representation or warranty made by any dealers or distributors selling its products beyond those herein expressly expressed unless expressed in writing by an officer of Hygiena Diagnostics GmbH;
- (5) Hygiena Diagnostics GmbH does not assume responsibility for incidental or consequential damages, including, but not limited to responsibility for loss of use of this product, removal or replacement labor, loss of time, inconvenience, expense for telephone calls, shipping expenses, loss or damage to property or loss of revenue, personal injuries or wrongful death;
- (6) Hygiena Diagnostics GmbH reserves the right to replace or allow credit for any modules returned under this warranty.

ADDITIONAL INFORMATION

foodproof®, microproof®, vetproof®, ShortPrep®, StarPrep®, RoboPrep® and LyoKit® are registered trademarks of Hygiena Diagnostics GmbH.

Hygiena® is a registered trademark of Hygiena.

Other brand or product names are trademarks of their respective holders.

3.1 Reference Number

The reference number and original Hygiena Diagnostics GmbH article number:

S 400 08.1

3.2 Change Index

Version 1, November 2019:

New document layout and content.

Revision A, December 2023:

Rebranding and layout

S 400 08.1 20-4 -> INS-KIT230177-4-REVA

Hygiena®

Camarillo, CA 93012

USA

diagnostics.support@hygiena.com

Manufactured by

Hygiena Diagnostics GmbH

Hermannswerder 17

14473 Potsdam

Germany

www.hygiena.com