



# Product Instructions

## Dualo 32<sup>®</sup> R2

Product No. MCH230003

**DU****LO 32® R2**

**Dualo 32® R2**

Product No.: MCH230003

**Product Instructions:**

Revision A, July 2023

# TABLE OF CONTENTS

This user guide will teach you what you need to know to start running your Dualo 32<sup>®</sup> R2 instrument. It describes everything from connecting your instrument to the network to data analysis for your qPCR experiments.

Contents include

## 1. SETUP

Learn how to install your Dualo 32 R2 - from setting it up on your workbench, to configuring the instrument and installing the software.

## 2. TIPS

Learn some useful tips for using your instrument.

## 3. EXPERIMENT

Learn the basics of setting up an experiment on your Dualo 32 R2.

## 4. ANALYSIS

Learn how to easily analyze your results.

## 5. EXPORT

Learn how to export your data for use with other software.

## 6. MAINTENANCE

Learn how to look after your Dualo 32 R2.

## 7. TROUBLESHOOTING

If you ever have a problem with your instrument, learn how to troubleshoot it here.

## SETUP

# 1. SETUP

## Installing your Dualo 32 R2

You should have the following items in the Dualo 32 R2 flight case:

1. Dualo 32 R2 qPCR Instrument
2. Power Supply Unit and Mains Cable
3. Ethernet Cable
4. USB Drive

Please keep the flight case and outer box the Dualo 32 R2 came in, in case you need to protect your Dualo 32 R2 during storage or shipment in future.

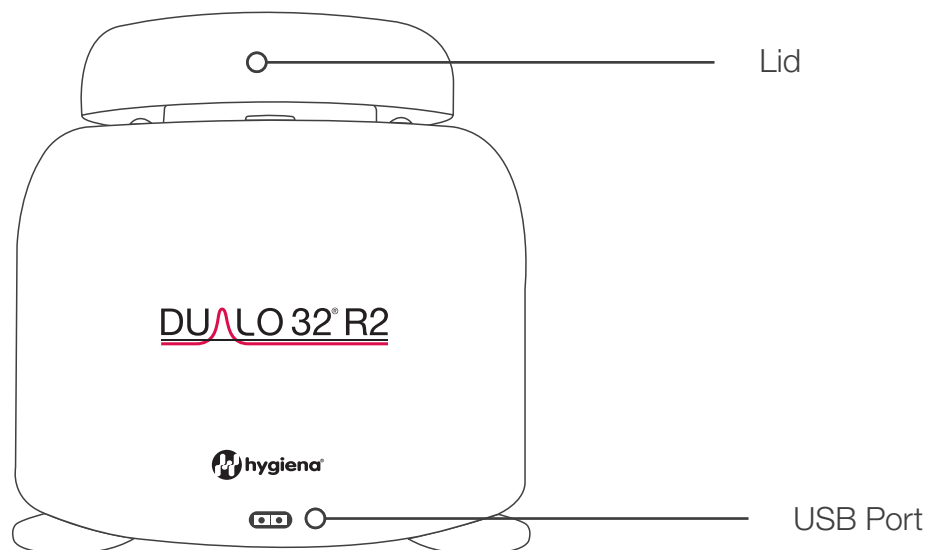

### Lid









The lid ensures that tubes are seated correctly in the wells, provides optical isolation, includes a heated lid to reduce condensation, and prevents dust falling into empty wells.

### USB Port

Insert the USB drive here to run an experiment from the USB drive.

## Display LEDs

The Dualo 32 R2 uses display LEDs to help you understand what the instrument is doing. Here is a summary of these display LEDs.

Blue		Initializing
Green		Idle
Red		Lid open - please close the lid
Yellow		Tubes loaded
Blue		Running, low temperature
Pink		Running, medium temperature
Red		Running, high temperature
Cyan		Experiment complete
Red-Flashing		Fault detected

## Dualo 32 R2 Connections

The Dualo 32 R2 has three connections. One in the front and two in back as shown below:

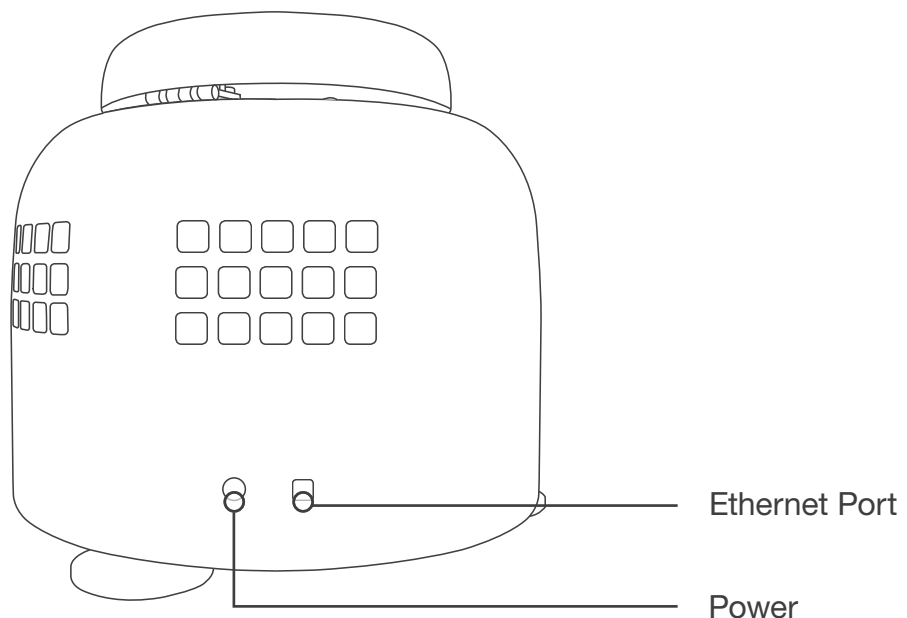

This is to connect your Dualo 32 R2 to the provided power supply unit.



This is for connecting your Dualo 32 R2 to your LAN or computer.

## SETUP

### Powering on your Dualo 32 R2

Place the Dualo 32 R2 on your lab bench and then connect AC power to the power supply unit. After a few seconds, your instrument will turn on. The display LEDs will light up blue and then turn green if a lid is closed or red if not. Your Dualo 32 R2 is ready to run. The Dualo 32 R2 uses a 3-pin IEC mains connector. If you are not using a grounded supply then you must provide an additional ground connection.

### Connecting your Dualo 32 R2

#### to a Network, PC or Laptop

Connect one end of the Ethernet cable to the instrument and the other end to a LAN port, or directly to your computer. Once your Dualo 32 R2 is connected to a LAN, you can connect to your instrument via Wi Fi if your network supports it.

#### Dualo 32 R2 Connection Modes



1. Direct network connection

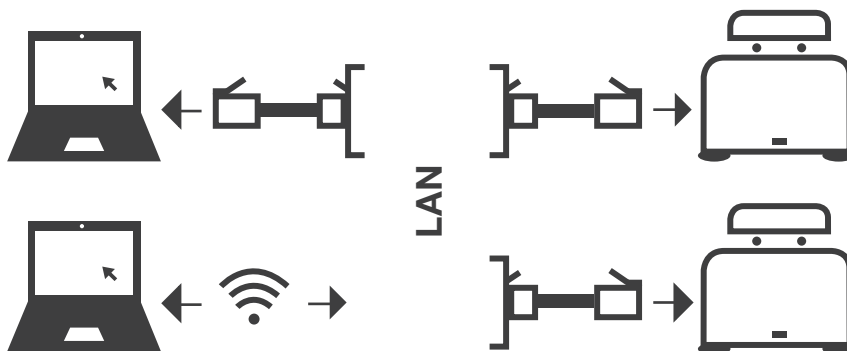

2. Local area network connection

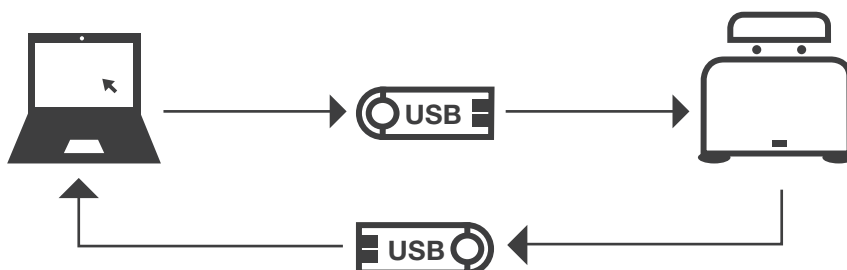

3. USB drive connection

## Dualo 32 R2 Heated Lid

The Dualo 32 R2 heated lid will get hot. Please do not touch it. The heated lid will be preheated to 105 °C if user activity is detected. This enables your run to start as soon as possible. After 5 minutes of inactivity, the heated lid will be turned off to conserve energy.

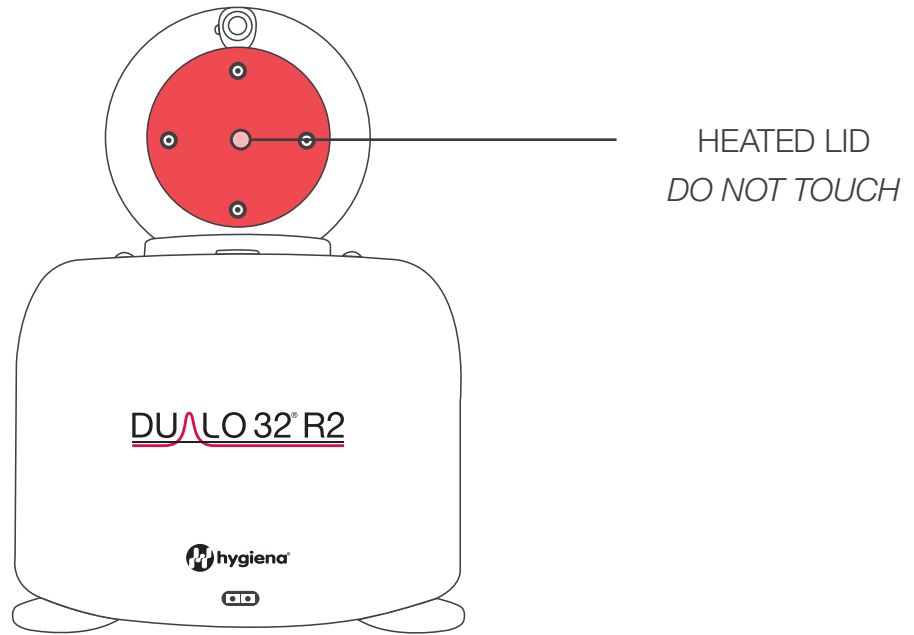

## Installing your Dualo 32 R2 Software

### WINDOWS (MAC OS X also available)

Double-click on the Dualo 32 R2-Windows-Installer and follow the on-screen instructions to install your Dualo 32 R2 software on Windows.

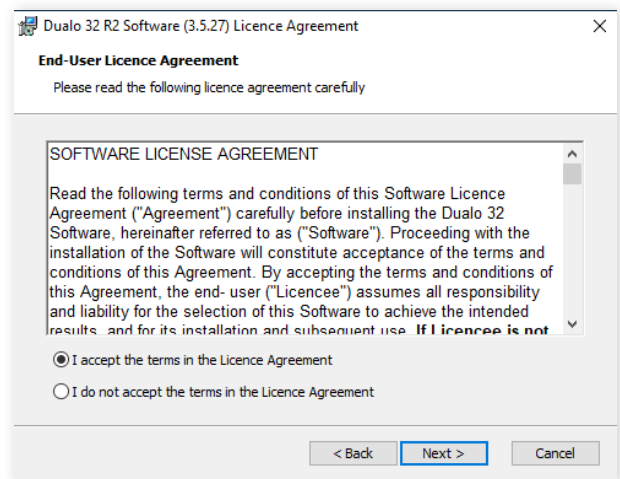

# SETUP

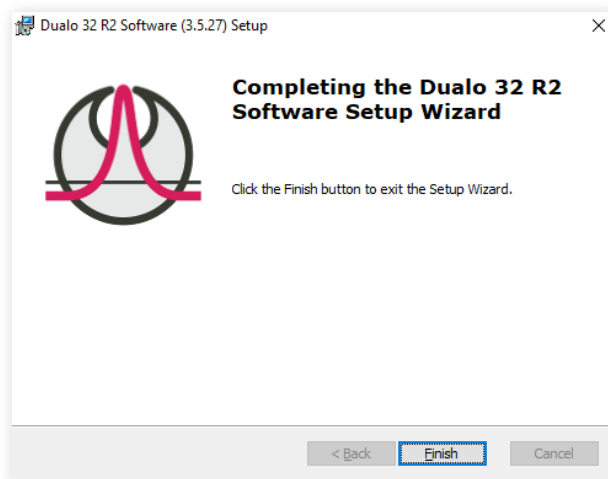
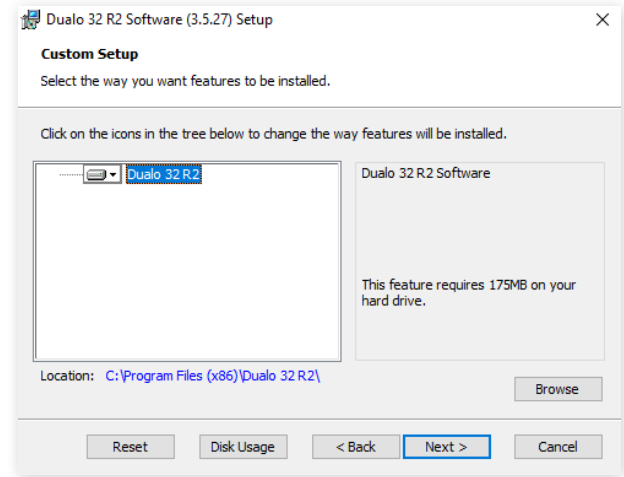
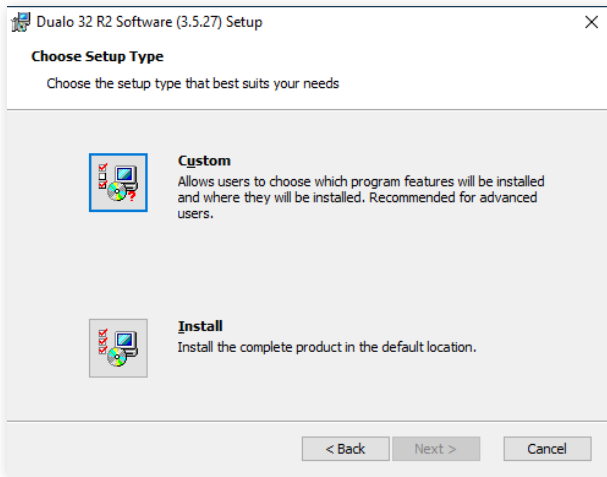
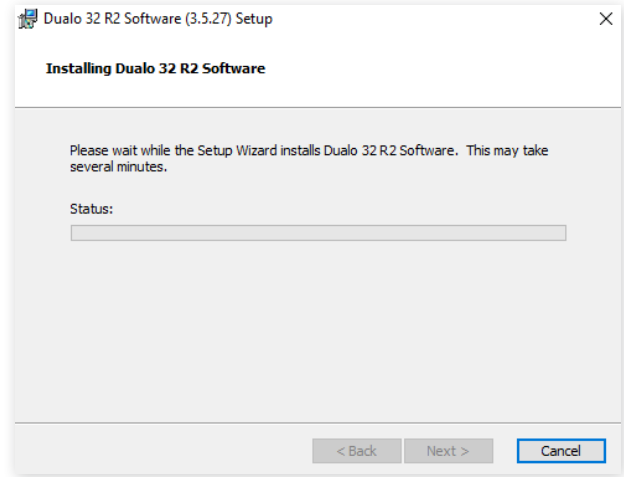
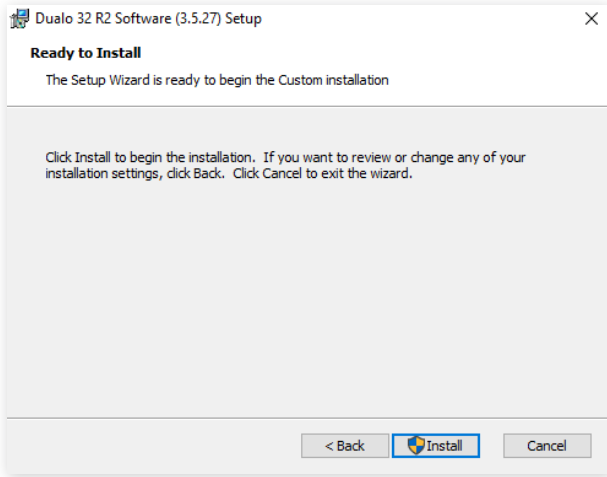



## Configuring your Dualo 32 R2

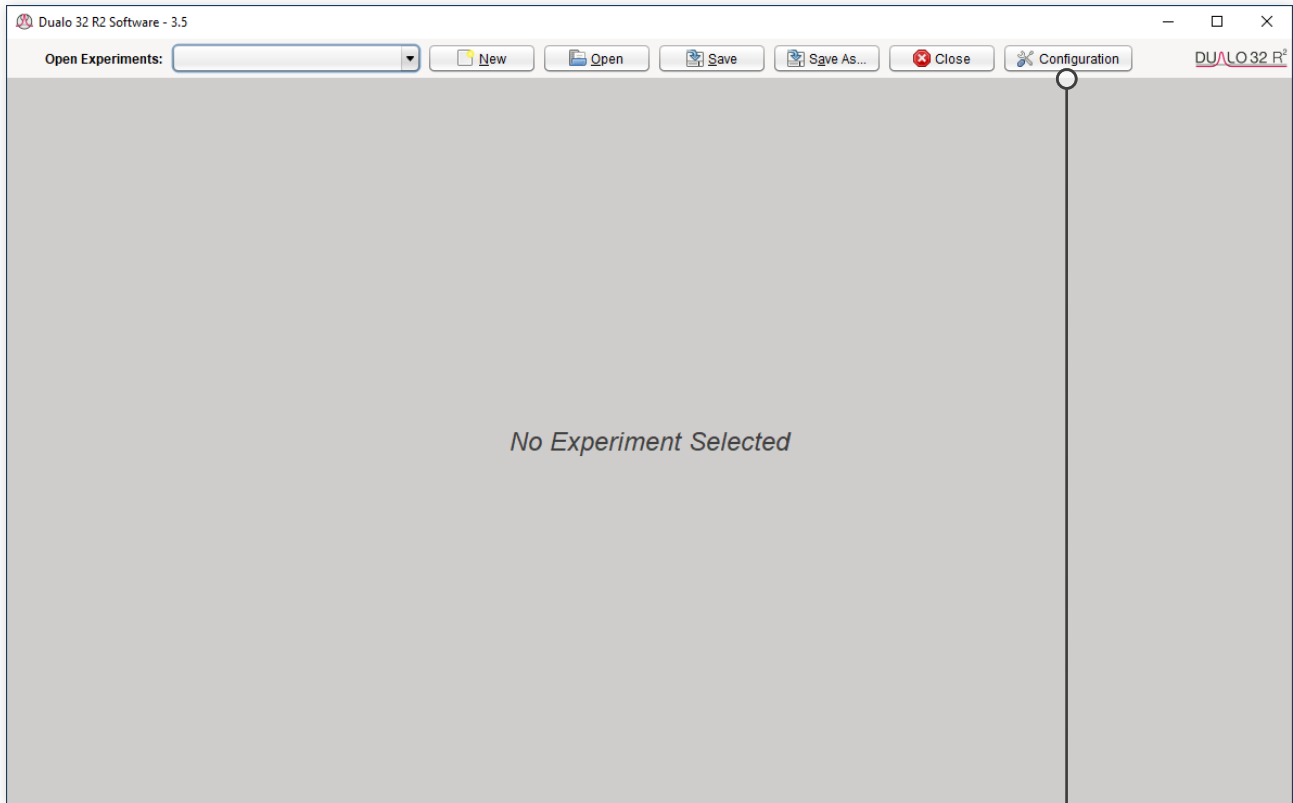

Please select Dualo 32 R2

Please select Configuration

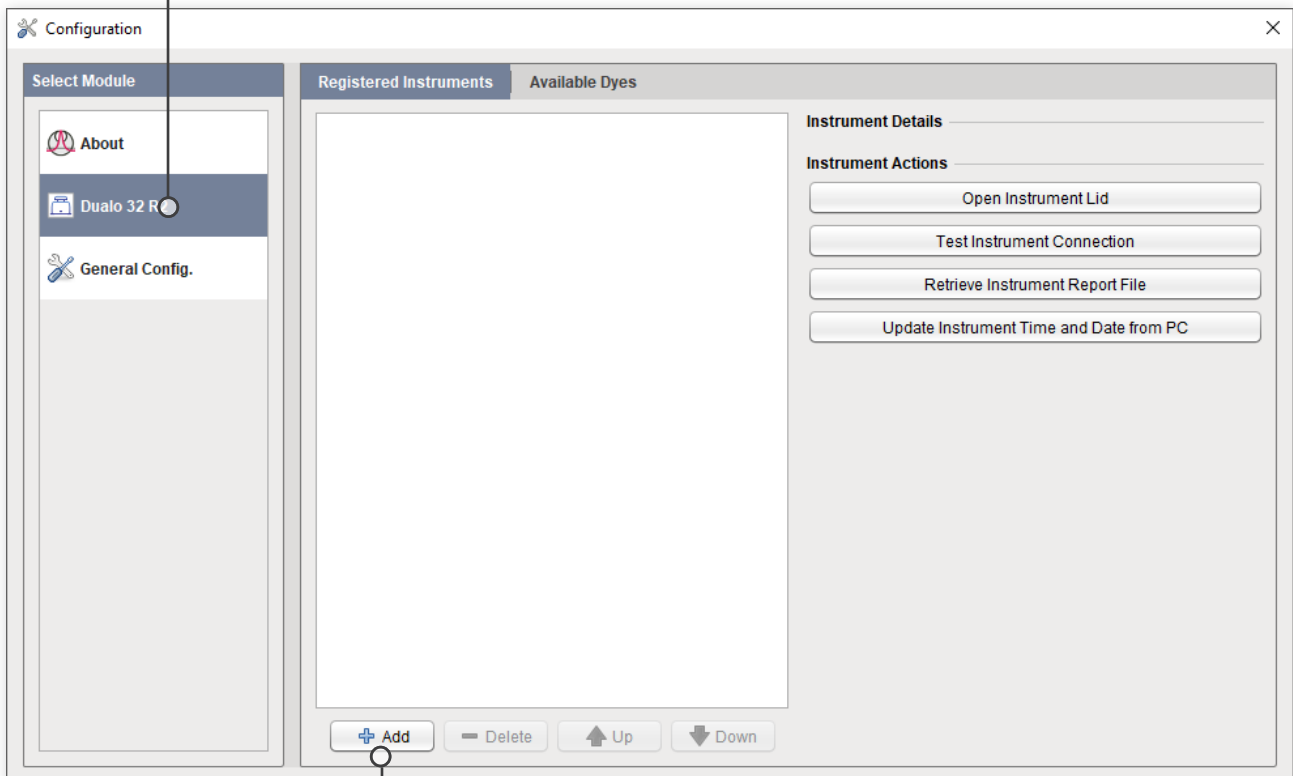

To add your new Dualo 32 R2, select the Add button.  
You will now be presented with a list of available instruments.

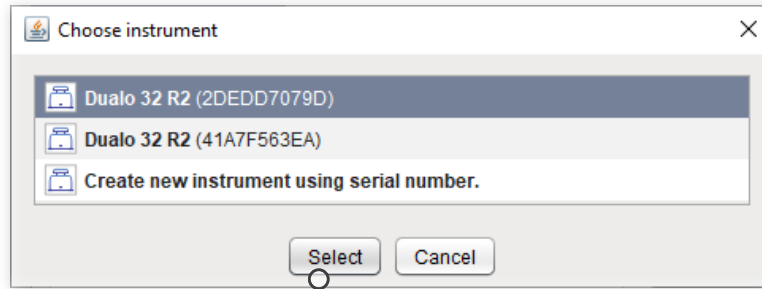

Double-click on the instrument you wish to connect to, or press **Select** with the instrument selected. The instrument will now be added to the list of **Registered Instruments** for use in the software.

## **2. TIPS**

Here are some great tips to keep in mind while running your Dualo 32 R2 instrument.

1. Lid gets warm
2. Do not leave the lid open
3. Spin your tubes
4. Remove all bubbles
5. Keep your lab clean
6. Keep your instrument clean
7. PC settings

### **Lid gets warm**

The Dualo 32 R2 lid can get warm during operation. This is completely normal.

### **Do not leave the lid open**

If the lid is open, dust may fall into the wells and affect the performance of your instrument.

### **Spin the tubes**

This will ensure all well contents are at the bottom of the wells and will improve performance.

## Remove all bubbles

Bubbles can cause optical artefacts as shown in the graph below. Ensure that no bubbles are present in reaction volumes.

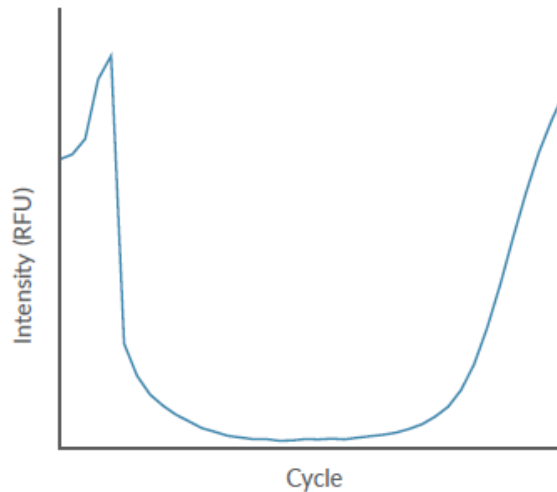

## Keep your lab clean

Please keep your work space clean including all lab equipment like surfaces, pipettes and tube racks. This will keep the instrument clean and help maintain good results.

## Keep your instrument clean

We recommend a routine cleaning of your instrument. To do so, follow the cleaning guide in the **Maintenance section**.

## PC settings

Please disable all power saving settings e.g., sleep and hibernate.

### 3. EXPERIMENT

This section will teach you everything you need to know to get started with Dualo 32 R2 experiments. You will learn how to create, save, open and close experiments. You will also learn how to set up sample information. Finally we will show you how to run your new experiment from the software, and from the USB drive provided.

#### Choose a New Experiment

Below is the Dualo 32 R2 home screen.

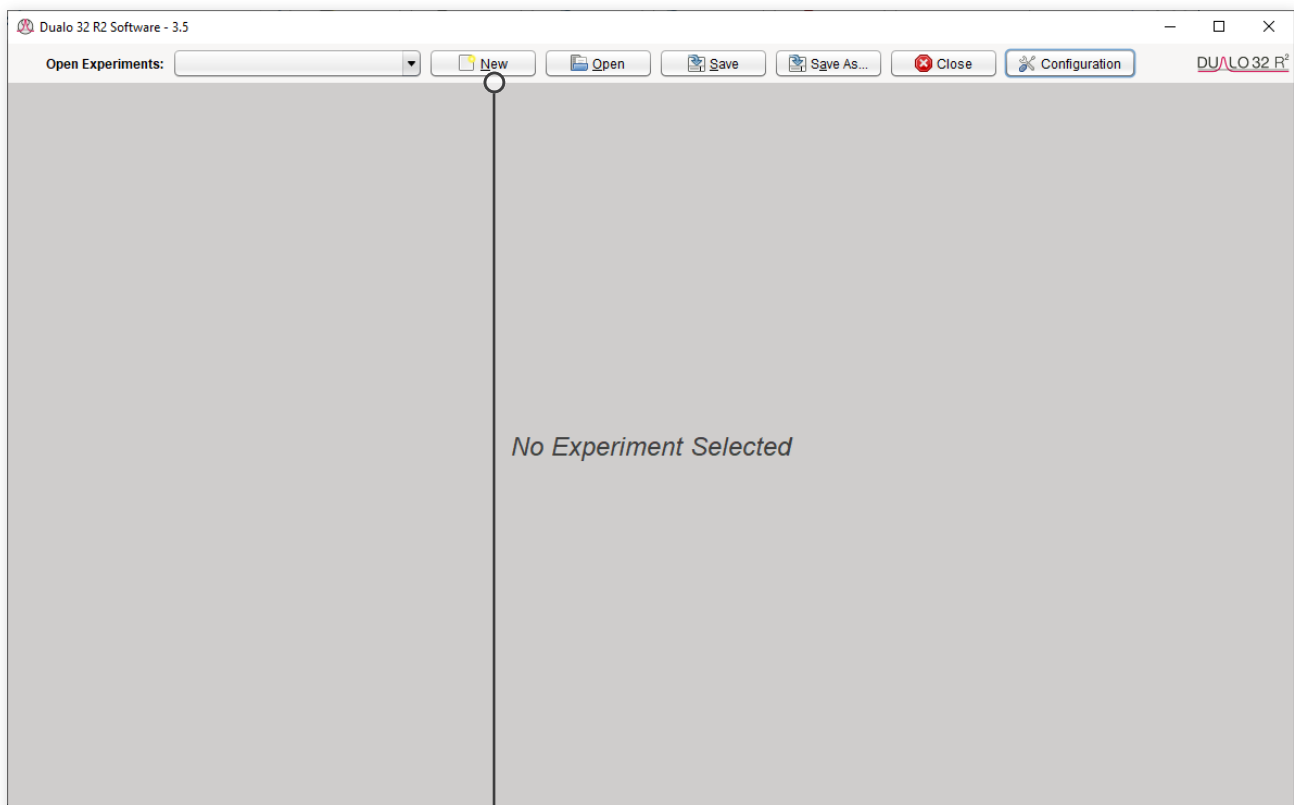

Click **New** to create a new experiment.

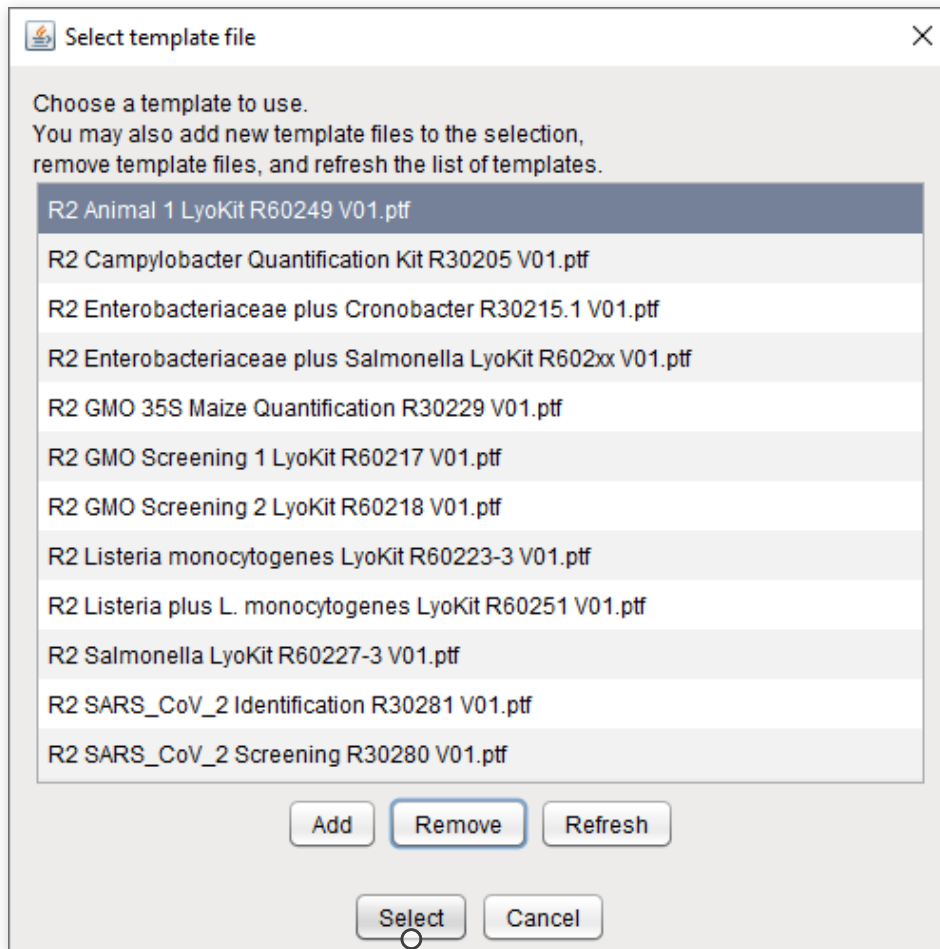

Choose a **Template** from the list by highlighting it, then click **Select**. By using a template you will be selecting pre-set parameters - temperature profile, optical and analysis settings to run an experiment.

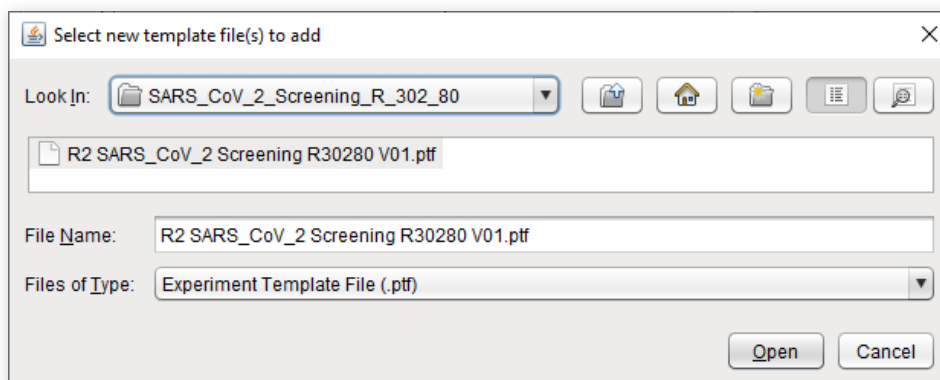

Choose **Add** to put a new **Template** to the list.

## Experiment Summary

Once you have chosen a new experiment from a template, the Experiment Summary will be displayed as shown below:

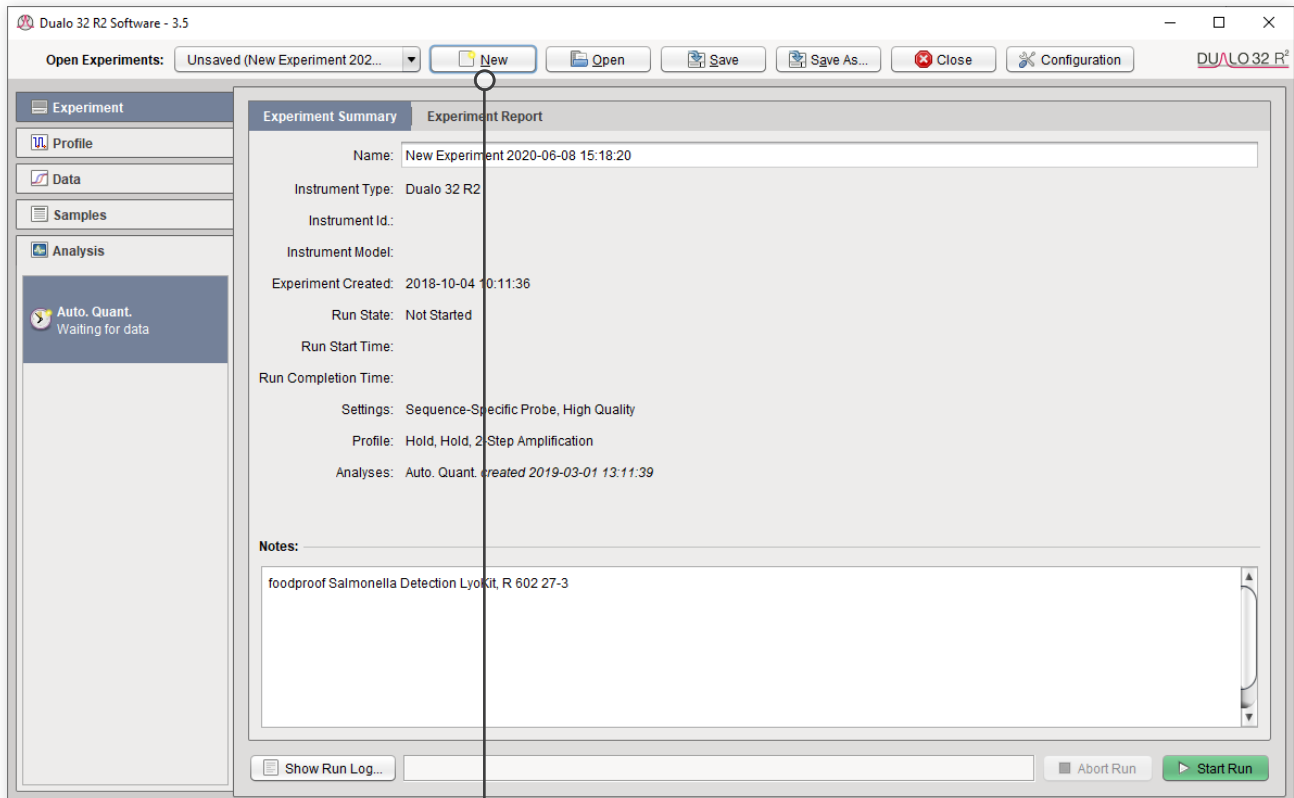

By default the experiment name will be “New Experiment” with a date and time stamp, which can be edited.

The summary will give you information about the instrument you are running, the settings chosen and any useful notes you choose to add about your experiment.

## Open an Experiment

By selecting Open, you can open an experiment as shown below:

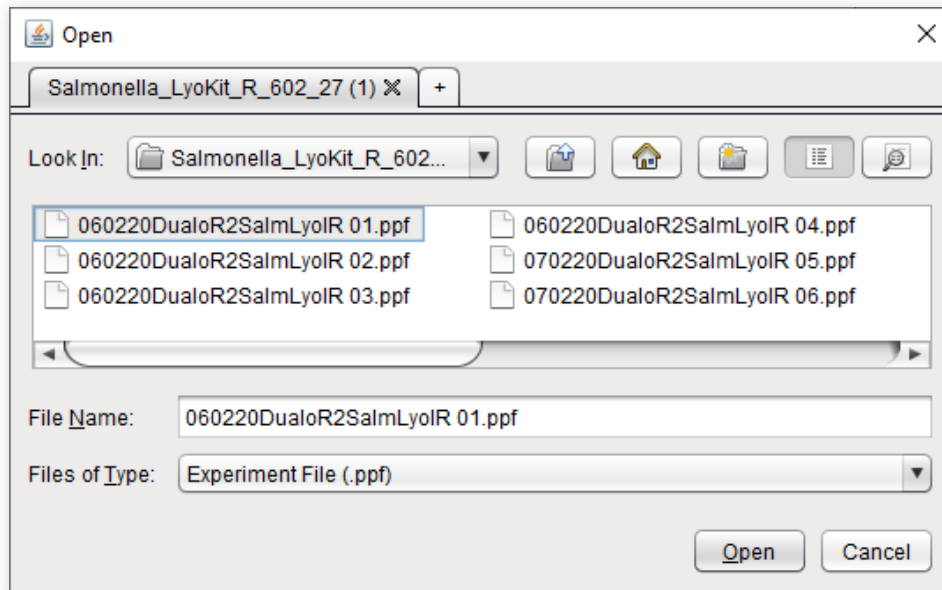

An experiment file will contain all the data and analyses, but cannot be re-run.

## USB Run

To open a USB run, navigate to the USB location using the Open dialog window shown below. Select Experiment File in the Files of Type drop down menu and then double click on the USB run.

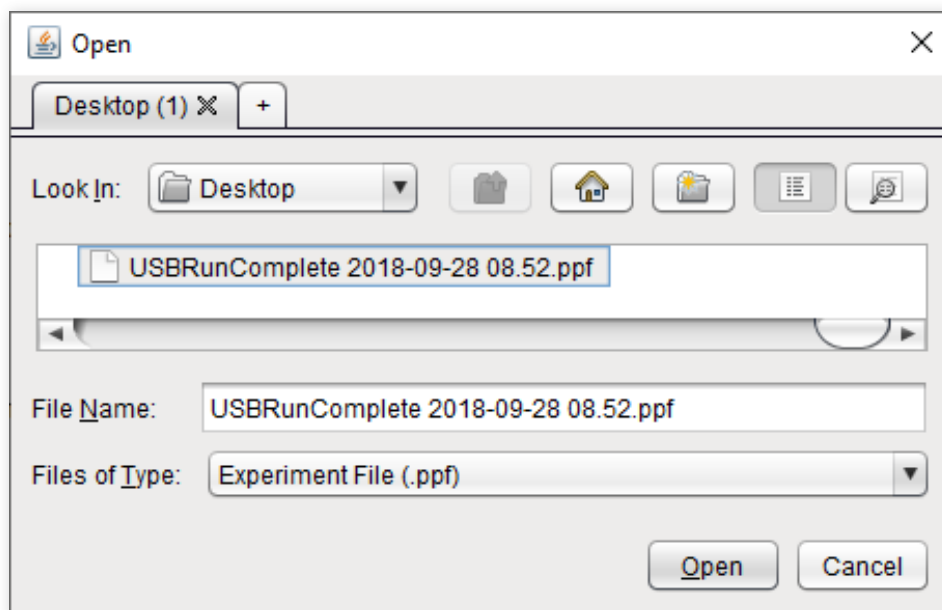



## Saving an Experiment

Once a run has finished, it can either be automatically saved to a pre-set location on your computer or manually saved by you. The experiment must be saved before the software is closed to ensure that data is not lost.

## Automatic Saving

When starting a run, you will be prompted with the window displayed below.

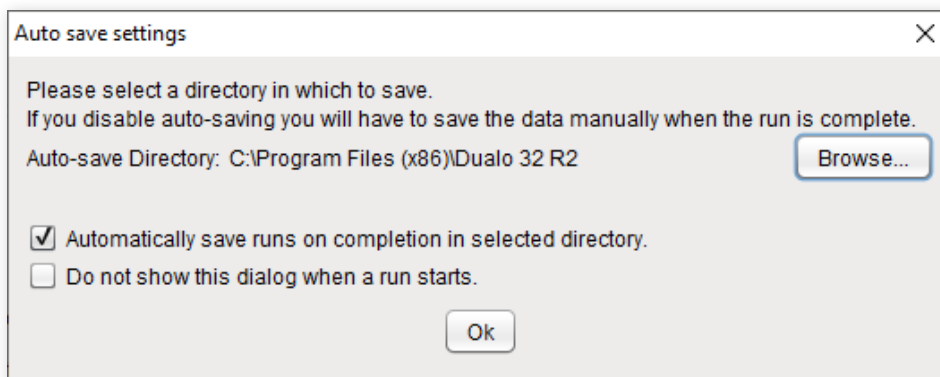

To automatically save your data when the run has finished, click **Browse** and choose the location to save your run to.

Make sure the first checkbox is selected and your experiments will be automatically saved. To prevent the software from showing this dialog again, select the second checkbox. You can change these settings later by clicking **Configuration** and selecting **General Config**.

## Manual Saving

Once your run has finished, you can save your experiment manually by clicking **Save** or **Save As**. The first time an experiment is saved, you will be prompted to select a location and filename to use. After this, you can click **Save** to use the same location, overwriting the previous version, or **Save As** to choose a new location.

## Closing an Experiment

To close an experiment, select **Close**. If the experiment has not been saved, the following dialog box will appear:

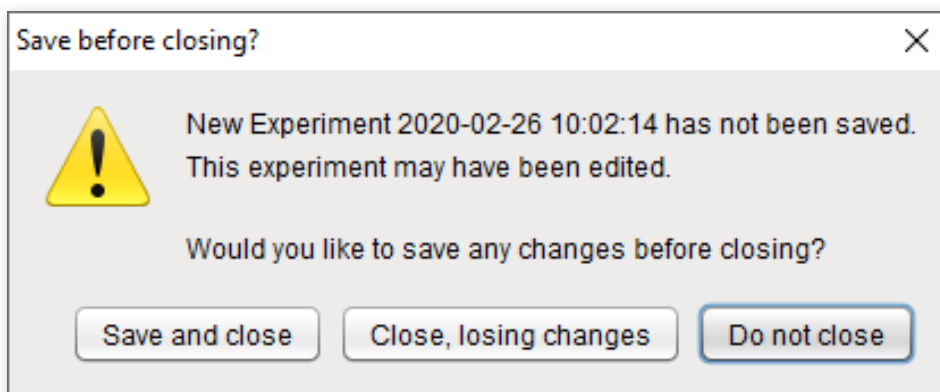

## Samples

You will now learn how to set up samples which can be defined as follows:

Samples or targets do not need to be defined before starting a run. They can be added to an experiment, while it is running or once it has finished. With a new experiment created, please select the **Samples** tab as shown below:

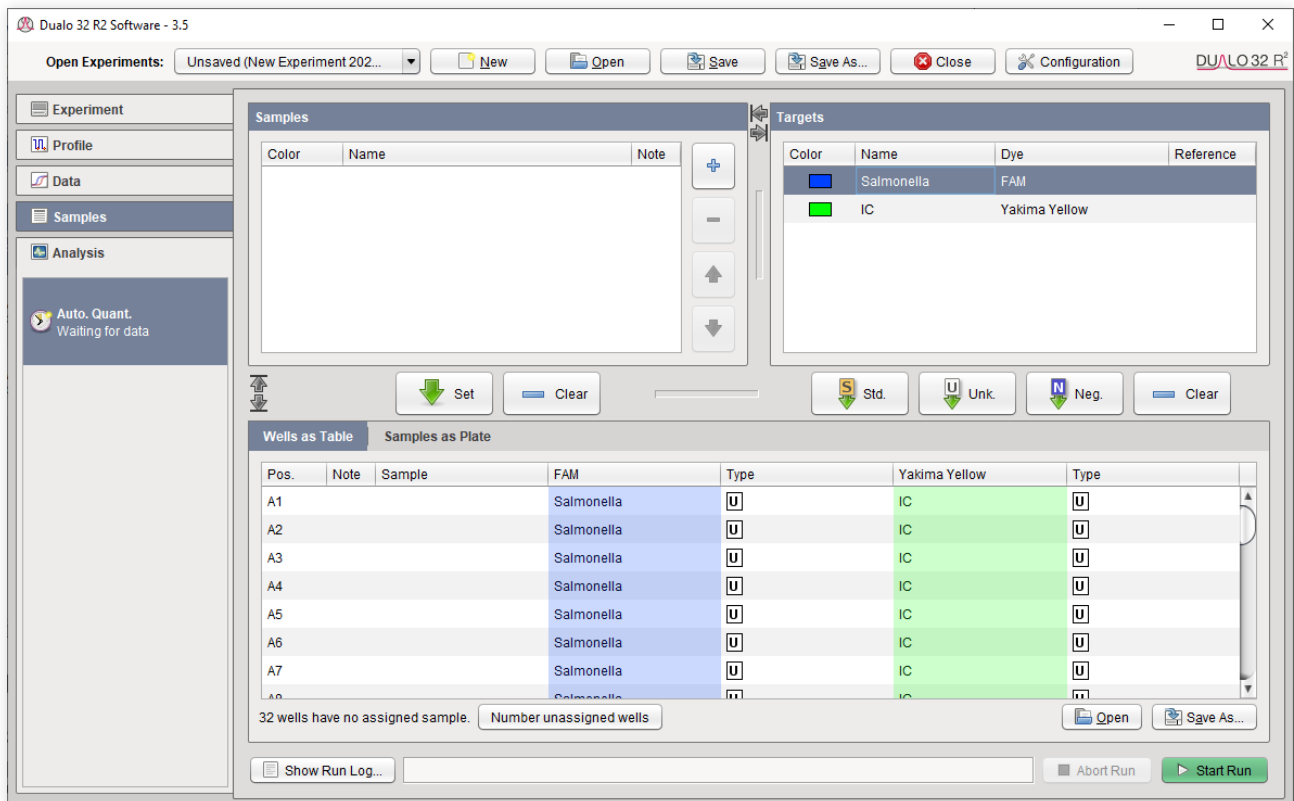

## Adding Samples



Samples can be added and removed from the experiment by selecting + and - in the **Samples** panes.

The order of samples can be altered by clicking the **Up** and **Down** arrows in the **Samples** panes.

## Assigning Samples to Wells

Assign wells by selecting them and clicking Set. Samples can also be unassigned by selecting wells you wish to un-assign and clicking Clear.



## Assigning Targets to Wells

Targets can be assigned to wells as a Standard, Unknown or Negative by clicking **Std.**, **Unk.** or **Neg.**, respectively. Assignments can be cleared by clicking **Clear** with the targets and wells you wish to clear selected. For more information about different types of standard controls, please contact technical support.

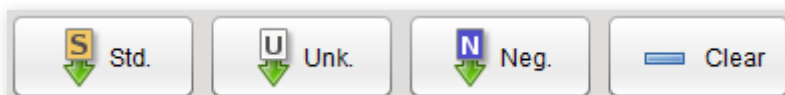

## Starting a Run from the Software

To start a run from the Dualo 32 R2 software, select **Start Run**. You will be presented with the auto-save options (unless you have chosen not to be prompted) and then be asked to choose an instrument from the list of **Registered Instruments**. Select an instrument and press **Select** to begin the run.

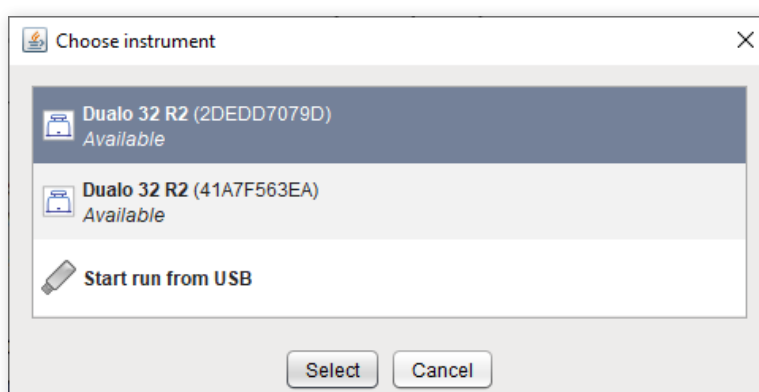
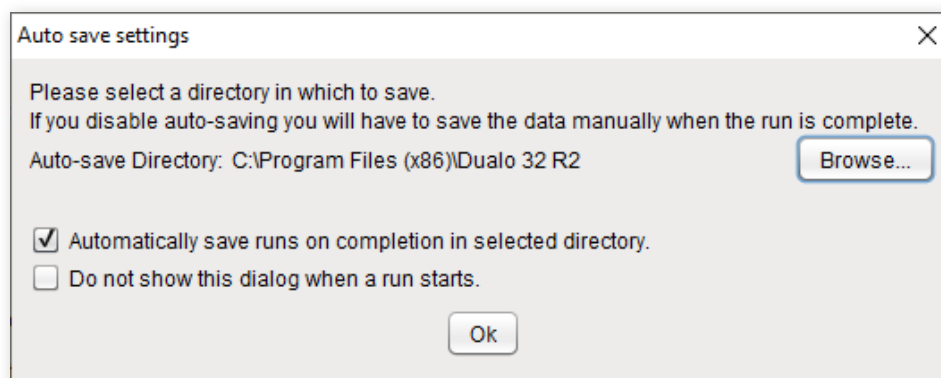

## Starting a Run from a USB Drive

To start a run using a USB drive, select **Start Run**. When you are asked to choose an instrument, select **Start run from USB**. You will then be prompted to find the location of your USB drive. Once selected, press **Save** and safely remove your USB drive as normal. The USB drive can now be placed into the instrument and your experiment will start automatically.

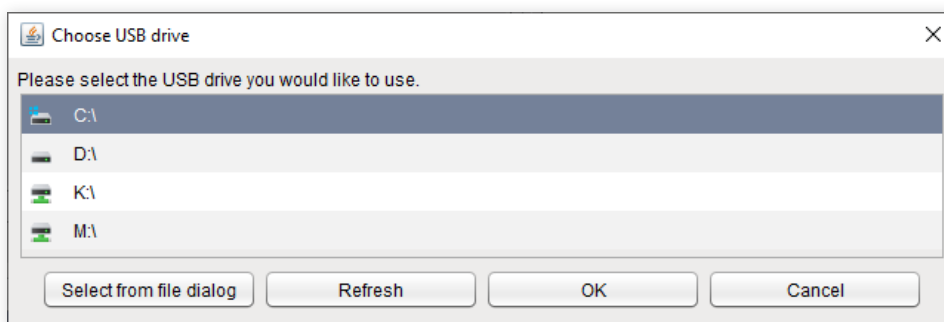
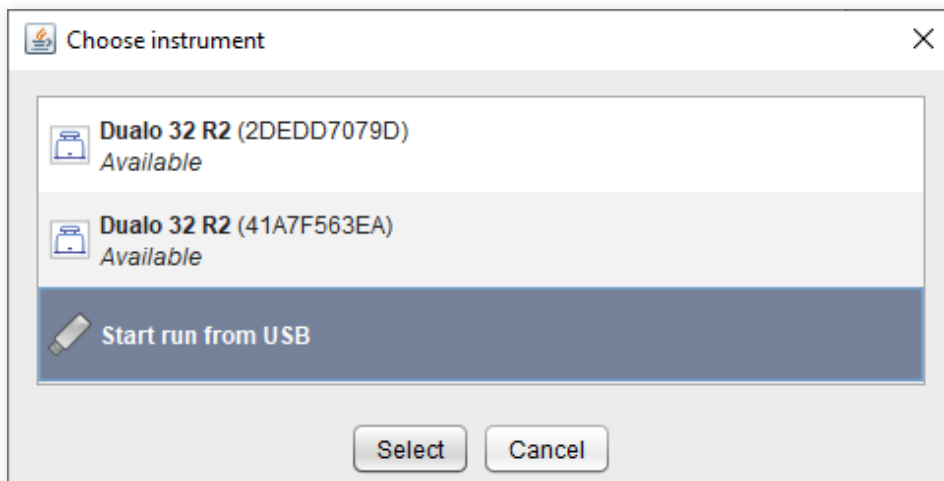

## Loading Strips into your Dualo 32 R2

In order to ensure that the heated lid is balanced, please make sure that the mount contains at least a strip in rows A and D (as shown in blue below) or single tubes in wells A1, A8, D1 and D8. These positions can be filled with tubes containing reagents, or empty tubes.

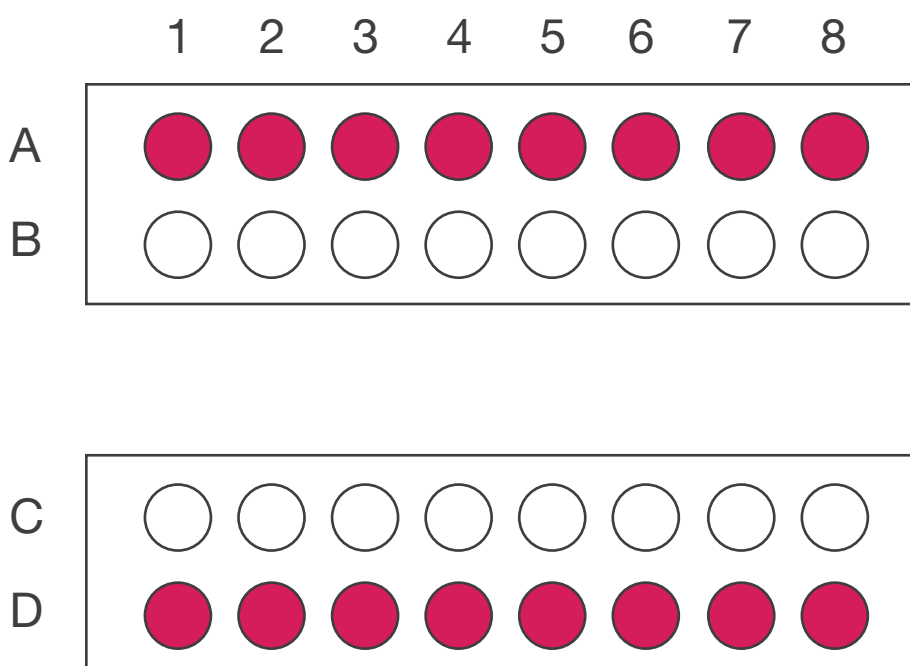

# 4. ANALYSIS

Depending on the chosen template, different types of analysis are pre-set.

## Auto Quantification

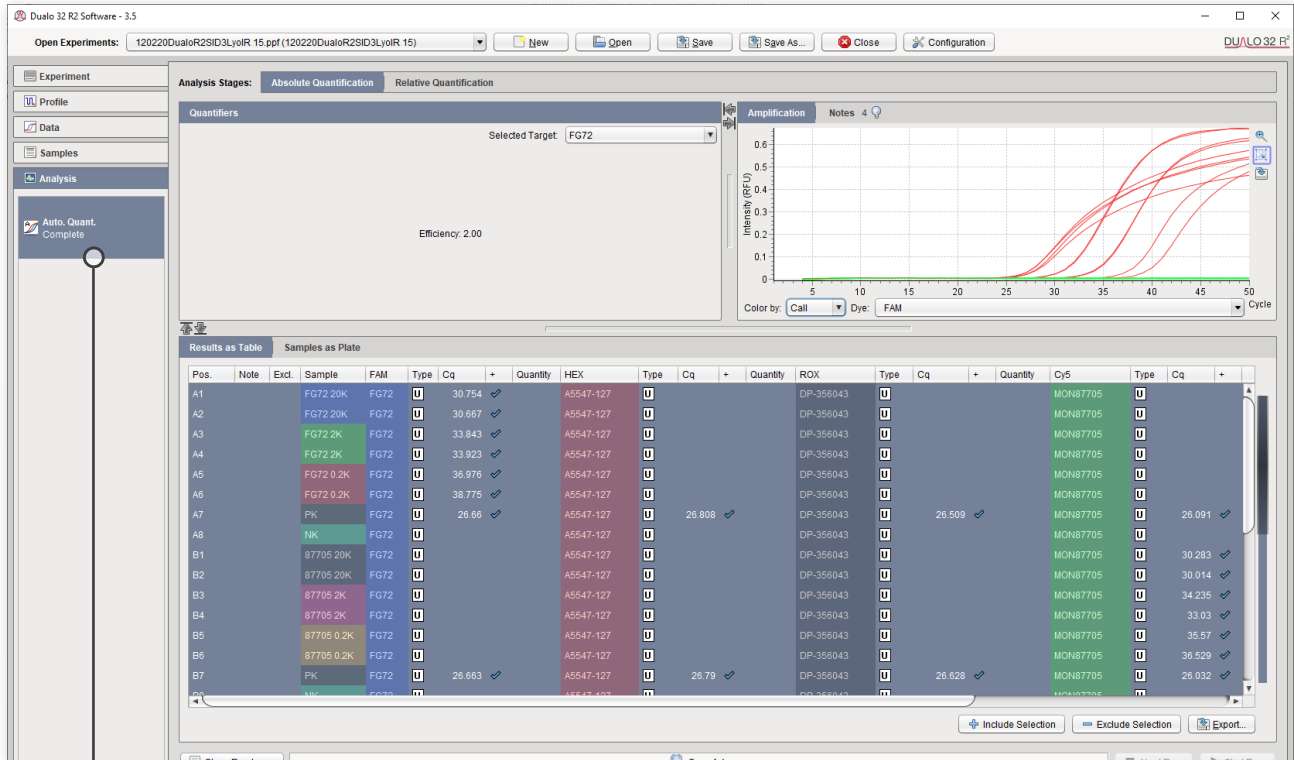

Click on the **Auto. Quant.** analysis in the Analysis pane on the left hand side of the screen.

## Quantifiers

If you have assigned standards with different known quantifiers to your experiment, for example a dilution series, you will be able to see your reaction efficiency by selecting Quantifiers. Here you will be shown the relationship between Cq and input template quantity, plus a variety of statistics derived from the standards.

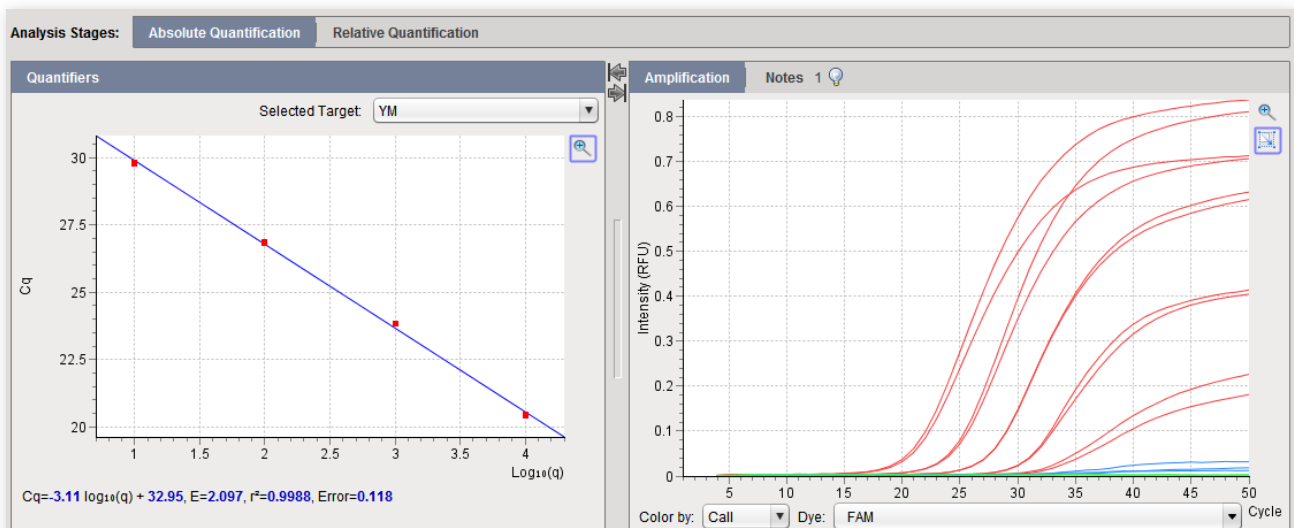

## Auto Tm Calling (Melting)

Select the analysis Automatic Tm Calling to identify and characterize melting peaks. You can see the results below.

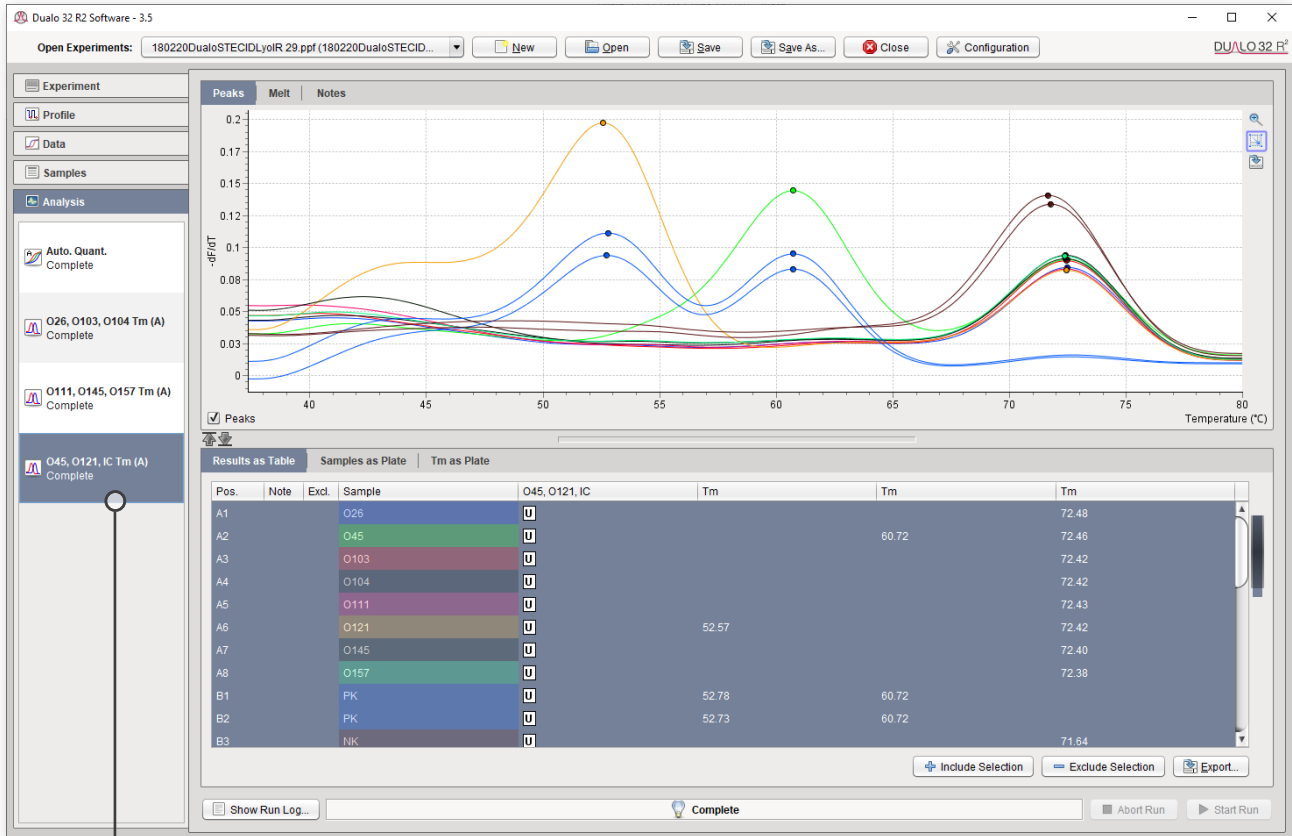

Click on the **Tm (A)** analysis in the Analysis pane on the left hand side of the screen.

## 5. EXPORT

When you have finished analyzing your data in the Dualo 32 R2 software, you can export the results in a variety of ways, from raw data to user defined custom reports.

### Data Export

You can export data from panes with results in tabular format by clicking the **Export** button.



Data can be exported in the following formats:

**CSV** This is an editable data file that can be opened in many spreadsheet applications.

**PDF** This file format is suitable for archiving, printing and presentations, but cannot be edited.

### Report Generation

Customizable reports can be generated from your experiment by selecting **Experiment Report** under the **Experiment** tab.

## 6. MAINTENANCE

This section will help you take care of your Dualo 32 R2. It covers the following areas:

1. Cleaning
2. Environmental Conditions
3. Disassembly



### Cleaning

#### Day-to-Day

For day-to-day cleaning, wipe the external surface of your instrument with a damp, soft, lint-free cloth. Dry your instrument with another soft, lint-free cloth.

**Notes:** Avoid abrasive cloths, towels, paper towels and similar items that might cause damage. Before cleaning your instrument, unplug all external power sources, devices and cables. Do not get moisture into any openings.



## MAINTENANCE

### Deep Cleaning Wells

Automated background subtraction processes mean that low levels of fluorescence contamination in the wells of your instrument will not affect system performance. Should one or more wells of your instrument become contaminated with high levels of fluorescent substances, and need cleaning, please contact technical support for guidance.

## Environmental Conditions

### Your Work Space

Your Dualo 32 R2 should be placed on a surface that is flat, dry and not subject to drafts. Do not install your 32 R2 instrument directly in the flow of air from an air conditioner or fan. Do not install your Dualo 32 R2 instrument in a dusty environment.

Do not cover or obstruct air flow around any part of the instrument, including the heated lid and the vents on the instrument base and back.

### Environmental Operating Conditions



#### HUMIDITY

MAX: 80% at +32 °C

MIN: 30% at +15 to +32 °C



#### TEMPERATURE

+15°C to +32 °C



#### PRESSURE

0 to 2000 MAMSL

80 to 106Kpa

### Environmental Storing / Transporting / Packing Conditions



#### HUMIDITY

10% at 95%

No condensation



#### TEMPERATURE

-20 °C to +60 °C



#### PRESSURE

0 to 3000 MAMSL

70 to 106Kpa

### Disassembly

Please note that your Dualo 32 R2 contains no user-serviceable components inside. Any disassembly of your Dualo 32 R2 instrument will void all warranties.

## Consumables

8 tube-strips, Product No. Z 100 87

8-Cap strip, Product No. Z 100 89

## 7. TROUBLESHOOTING

This section will help you troubleshoot your Dualo 32 R2 if you think something is wrong.

### FAQ

Here are some frequently asked questions, and the answers.

---

**Can I leave my Dualo 32 R2 powered on overnight?**

Yes. It is safe to leave your Dualo 32 R2 overnight. It will enter a low power standby mode.

---

**Where is the threshold for determining Cq values in Auto Quant?**

Modern methods of determining Cq values are not based on simple thresholds. Modern methods of Cq determination are model based. Auto Quant fits a model of a PCR amplification to the fluorescence data observed. This model fit then enables the estimation of a number of important parameters including Cq values.

---

## Error Messages

Your Dualo 32 R2 will let you know when something is wrong by displaying an error. Most errors are reported as messages in the Status Bar in the 32 R2 software. Some errors are reported by the instrument display LEDs.

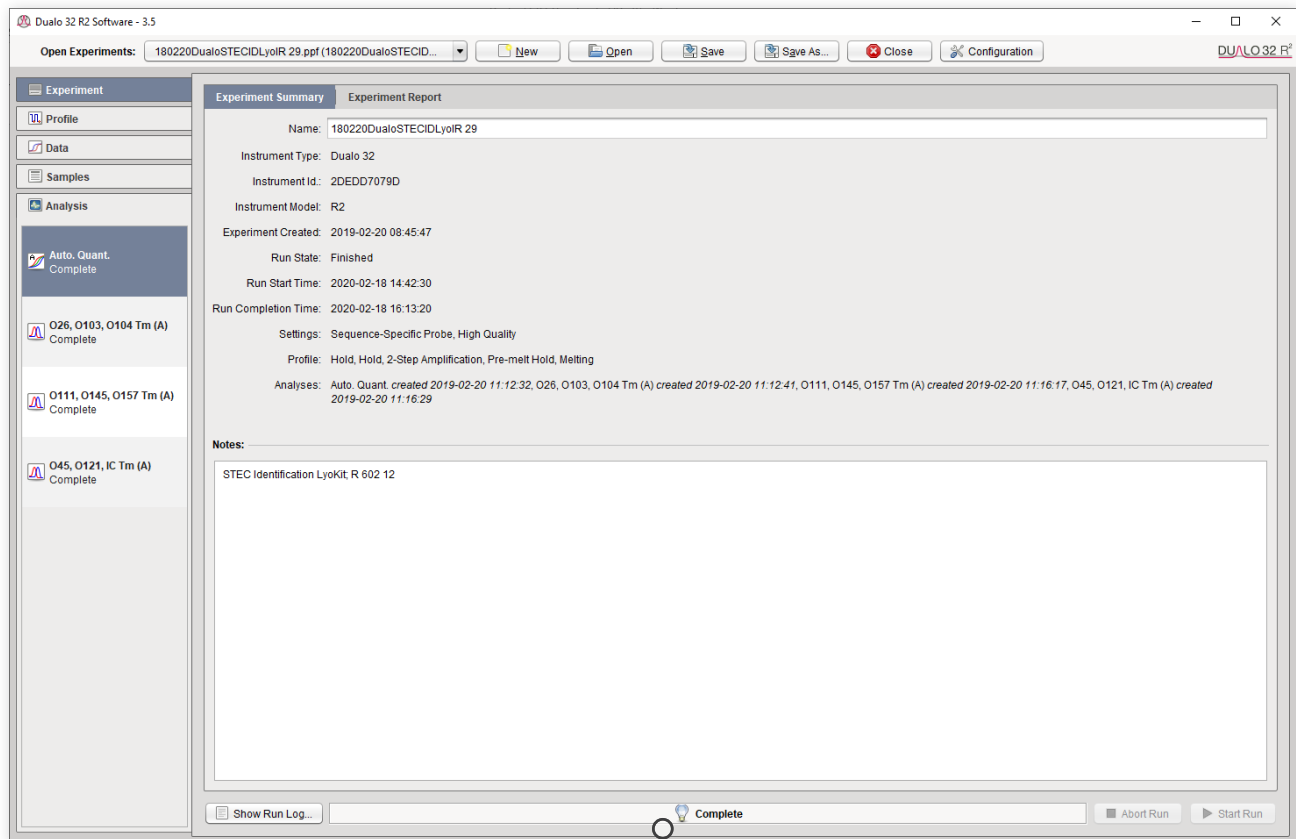

Status Bar.

If you encounter an error, please make sure that the instrument is running in a lab within the specified environmental conditions, tubes have been loaded correctly, the lid has been fitted correctly and all cables are attached correctly and securely. If the error still occurs, you may need to contact technical support with the following actions described below.

## Error Messages - Displayed in Status Bar

<b>Message</b>	<b>Action</b>
<p>Run Prepare Error (followed by one of the following messages)</p> <ul style="list-style-type: none"><li>a) No tubes loaded.</li><li>b) Instrument has had a hardware error and is in failsafe mode.</li><li>c) Instrument is not yet ready to run.</li><li>d) Instrument has finished a run and is waiting for tubes to be removed.</li><li>e) Open lid, remove tubes and then add new ones.</li></ul>	<p>Please follows the instructions in the error message and continue as normal.</p>
<p>FAILURE</p>	<p>This message will be followed by a short code. Please contact Technical Support.</p>
<p>Instrument connection too slow</p>	<p>May be reported at the start of a run. Please check that your network is properly configured and is operating at 100Mb/s or more.</p>
<p>Network error</p>	<p>Please check that your network is properly configured and is operating at 100Mb/s or more. Always leave your laptop or PC turned on throughout the run and do not use any sleep, power-save or hibernate function. Do not close laptop lid. Alternatively, perform the run using a USB drive.</p>

## Error Log Files

In the unlikely event that you encounter a problem, the software can produce log files. These files help to diagnose the problem.

## Software Errors

For software issues, go to **Configuration > About** and select **Save Software Logs to File**.

## Hardware Errors

For Hardware faults go to **Configuration > Dualo 32 R2** and select **Retrieve Instrument Report Files**. Once exported, please make sure you send the error file, the serial number and the experiment file that contained the error to Technical support. It is OK to send experiments that have not completed and/or were aborted.

## **WARRANTY AND DISCLAIMER OF LIABILITY**

### **WARRANTY AND DISCLAIMER OF LIABILITY**

Limited Warranty and Disclaimer of Liability: Hygiena® Diagnostics GmbH warrants that this product is free from defects in materials and workmanship for 12 months and only if the following are complied with:

- (1) The product is used according to the guidelines and instructions set forth in the product literature.
- (2) Hygiena Diagnostics GmbH does not warrant its product against any and all defects when: the defect is as a result of material or workmanship not provided by Hygiena Diagnostics GmbH; defects caused by misuse or use contrary to the instructions supplied, or if the product is contaminated by improper storage or handling.
- (3) All warranties of merchantability and fitness for a particular purpose, written, oral, expressed or implied, shall extend only for a period of one year from the date of manufacture. There are no other warranties that extend beyond those described on the face of this warranty.
- (4) Hygiena Diagnostics GmbH does not undertake responsibility to any purchaser of its product for any undertaking, representation or warranty made by any dealers or distributors selling its products beyond those herein unless expressed in writing by an officer of Hygiena Diagnostics GmbH.
- (5) Hygiena Diagnostics GmbH does not assume responsibility for incidental or consequential damages, including, but not limited to responsibility for loss of use of this product, removal or replacement labor, loss of time, inconvenience, expense for telephone calls, shipping expenses, loss or damage to property or loss of revenue, personal injuries or wrongful death.
- (6) Hygiena Diagnostics GmbH reserves the right to replace or allow credit for any modules returned under this warranty.

## Ordering Information

Contact your local Hygiena Diagnostics GmbH representative for ordering information.

---

<b>Order Number</b>	<b>Product Name</b>
MCH230003	Dualo 32®R2 real-time PCR instrument

---

## Trademarks

Dualo 32® is a trademark of Hygiena Diagnostics GmbH.

Hygiena® is a registered trademark of Hygiena.

Other brand or product names are trademarks of their respective holders.

## Change Index

*Version 1, June 2020:*

First version of the package insert

*Revision A, July 2023:*

Rebranding and numbering

**Manufactured in the United Kingdom for  
Hygiena Diagnostics GmbH**

Hermannswerder 17  
14473 Potsdam  
Germany

[www.hygiena.com](http://www.hygiena.com)

For inquiries, please contact your nearest Hygiena office:

[www.hygiena.com/Support](http://www.hygiena.com/Support)