

foodproof[®]

StarPrep[®] Three Kit

Salmonella

PRODUCT INSTRUCTIONS

Documentation for the rapid DNA extraction from
Salmonella enrichment cultures for direct use in PCR

Product No. KIT230187/ KIT230188

foodproof®
StarPrep® Three Kit:
Salmonella

Store kit at 15 to 25 °C
FOR *IN VITRO* USE ONLY

Product No. KIT230187
21 mL volume

Product No. KIT230188
8-strip, 480 reactions

Product Instructions:
Revision A, September 2023

TABLE OF CONTENTS

1. OVERVIEW 4

1.1 General Information 4

1.2 Applicability 4

1.3 Kit Contents..... 5

2. INSTRUCTIONS 7

2.1 Required Material 7

2.2 Precautions and Preparations 9

2.3 Workflows 10

 2.3.1 Extraction Procedure A: Standard..... 11

 2.3.2 Extraction Procedure B: High Throughput 13

 2.3.3 Extraction Procedure C: Rapid..... 16

2.4 Troubleshooting..... 18

2.5 Support..... 19

3. ADDITIONAL INFORMATION 20

3.1 General Information 20

3.2 Reference 21

3.3 Change Index 21

INSTRUCTIONS

1. OVERVIEW

The foodproof® StarPrep® Three Kit is designed for the rapid preparation of DNA from gram-negative bacteria like *Salmonella* for direct use in PCR. In less than 30 minutes, preparation with this lysis buffer yields PCR template DNA from enrichment cultures. The extracted DNA can be used directly in any PCR application. The StarPrep Three Lysis Buffer eliminates the need for hazardous organic extractions or chaotropic agents. The entire DNA preparation can be performed in a single tube, minimizing handling steps and exposure to hazardous material. The reduced number of handling steps saves time. Transfer steps of DNA-containing extracts are not necessary, thus cross-contamination risks are minimized.

1.1 General Information

Number of Reactions

The kit is designed for 96 reactions (KIT230187) or 480 reactions (8-Strip Kit, KIT230188).

Storage Conditions

Store at 15 to 25 °C.

The components of the foodproof StarPrep Three Kit are guaranteed to be stable through the expiration date printed on the label.

1.2 Applicability

The lysis buffer is optimized for the preparation of enrichment cultures of various types of sample material, including meat and meat products, milk and eggs. The sample volume varies depending on which matrix is being tested. For very cloudy supernatants, or samples containing inhibitors, a reduction of the sample volume may enhance the DNA isolation efficiency. The quality of the DNA obtained with the lysis buffer is suitable for any PCR application.

INSTRUCTIONS

1.3 Kit Contents

A schematic representation of the foodproof StarPrep Three Kit for the standard and the large version with all its components.

KIT230187

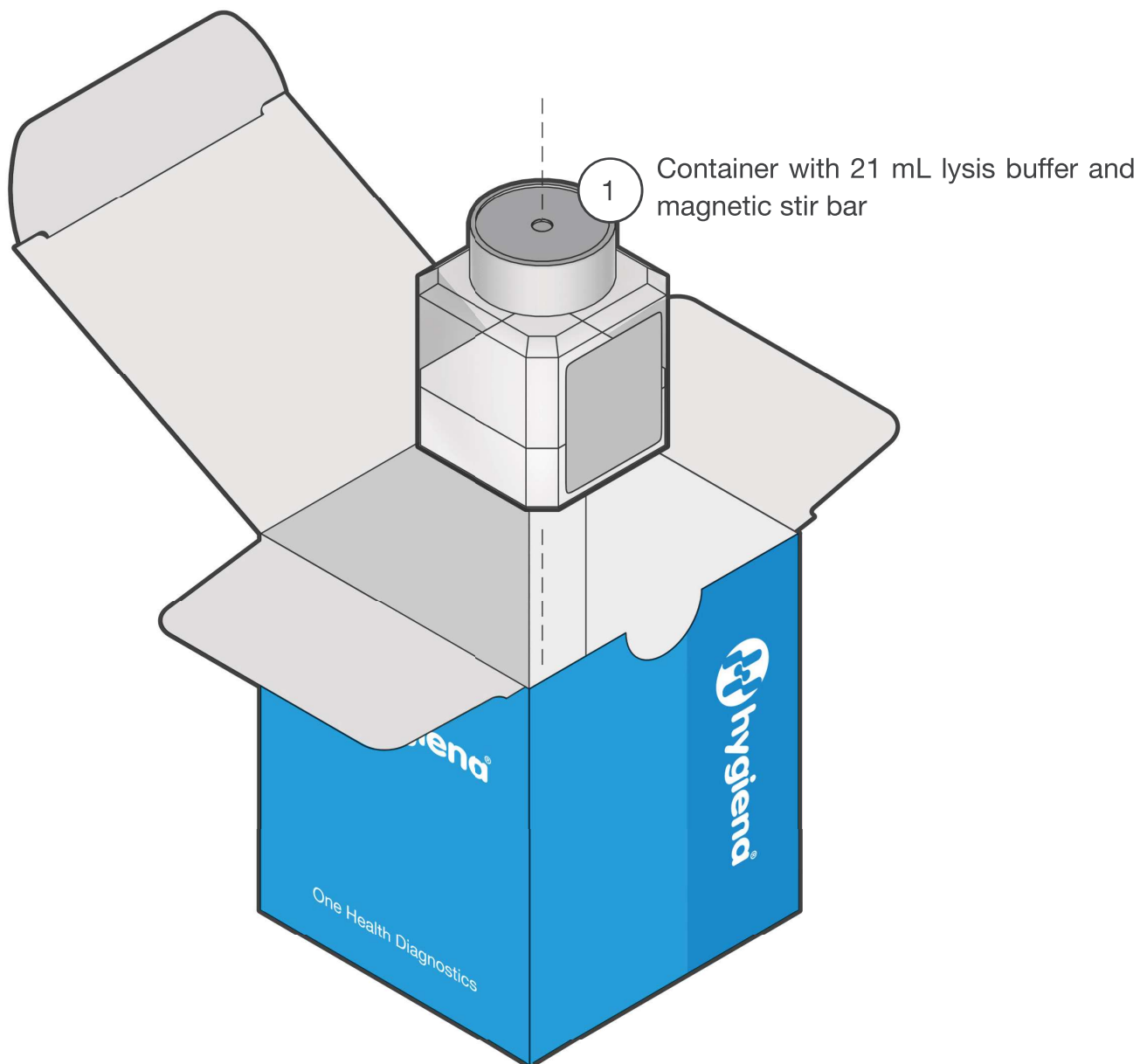

KIT230188

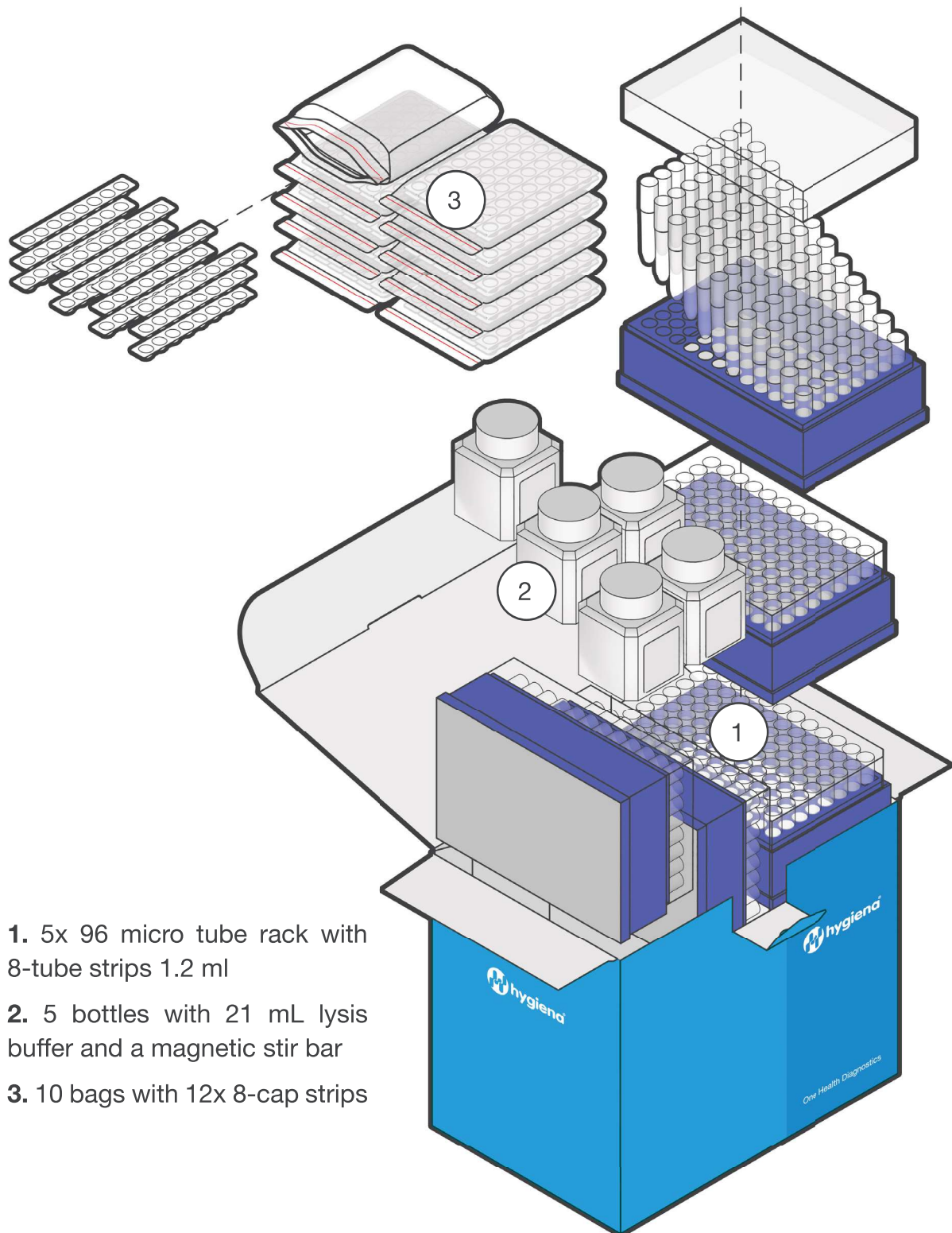

1. 5x 96 micro tube rack with 8-tube strips 1.2 ml
2. 5 bottles with 21 mL lysis buffer and a magnetic stir bar
3. 10 bags with 12x 8-cap strips

INSTRUCTIONS

2. INSTRUCTIONS

This section provides all information for a seamless DNA extraction from a variety of matrices.

2.1 Required Material

Most of the required equipment and reagents are available through Hygiena®. Please contact us for further information.



It is highly recommended only to use the materials described below to guarantee the robustness of the method.

Equipment for procedure A: Standard

- Standard tabletop **microcentrifuge** capable of a 13,000 × g centrifugal force
e.g., Micro Star 17 - VWR

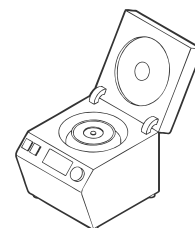

- Heating unit** suitable for 1.5 mL tubes
e.g., AccuBlock™ - Labnet with heating block

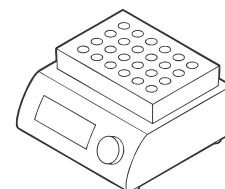

- Vortex mixer**
e.g., Vortex Genie - Scientific Industries

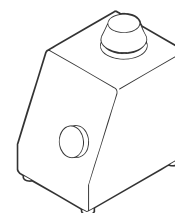

Recommended:

- Magnetic Stirrer**
e.g., Color squid IKAMAG® - IKA®-Werke



INSTRUCTIONS

Equipment for procedure B and C

- Multichannel pipette** and filter tips for **50 to 1,250 µL**
e.g., 8-Channel Pipette Viaflo - INTEGRA Biosciences,
50 to 1,250 µL GripTips for Viaflo
or EP Xplorer Plus Electronic Multichannel Pipette,
50 to 1,250 µL filter tips



- Centrifuge** with swing-out rotor for microtiter plates capable of:
 > 5,400 × g centrifugal force
e.g., Sigma 4-16S including rotor
 or 2,000 × g centrifugal force
e.g., Sigma 2-7 including rotor

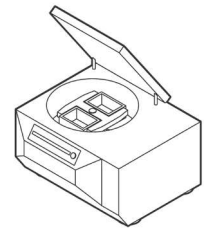

- TH 21 heating block thermostat**

- Exchange block for deepwell plates for TH 21

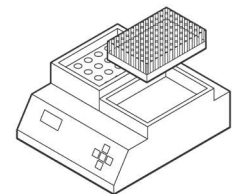

- Lid weight** with **incubation frame** for TH 21 heating block thermostat

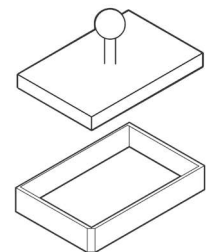

- Decapper 8-strip**

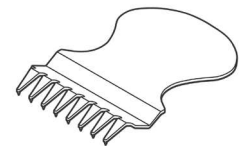
**Recommended:**

- Magnetic stirrer**
e.g., Color squid wave - IKA®-Werke



INSTRUCTIONS

-
- Cap installing tool**

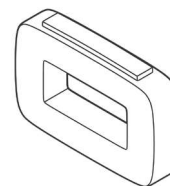

Consumables for procedure B and C

-
- Sterile
- reservoir**
- , 25 mL or 100 mL

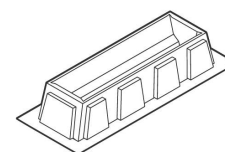

2.2 Precautions and Preparations

Follow all universal safety precautions governing work with biohazardous materials, e.g., wear lab coats and gloves at all times. Properly dispose of all contaminated materials, decontaminate work surfaces, and use a biosafety cabinet whenever aerosols might be generated.

For more information, please refer to the appropriate material safety data sheet (SDS). The SDS is available online at www.hygiena.com/sds.

-
- Always use filter tips in order to avoid cross-contamination.

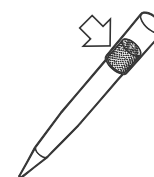

-
- Mix thoroughly while pipetting the buffer for sample preparation (Procedure A).

It is not recommended to use more than 96 reactions per 50 mL bottle. The container must retain some of the reagent.

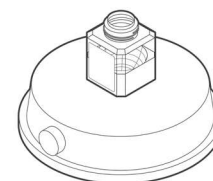

-
- Set the heating unit to 95 to 100 °C.

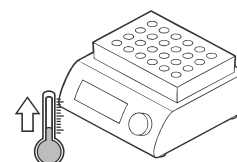

INSTRUCTIONS

2.3 Workflows

The following procedures describe the DNA isolation from enrichment cultures. For small sample quantities (up to 16 samples), use Procedure A: Standard, in combination with Product No. KIT230187. For sample quantities higher than 16, use Procedure B: High Throughput, or Procedure C: Rapid. Extraction procedures B and C are using 8-strip tubes and multichannel pipettes in combination with Product No. KIT230188.

2.3.1 EXTRACTION PROCEDURE A: STANDARD

The following protocol describes the DNA isolation from 100 µL enrichment culture (20 to 24 h) or from 500 µL short time enrichment culture (8 h BPW enrichment) of meat samples.



1. SHAKE SAMPLE

Shake enrichment culture gently and let the suspension settle for 5 to 10 min.

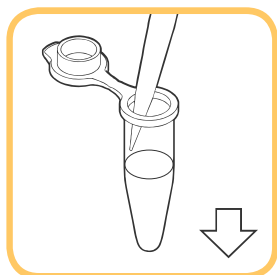

2. ADD SAMPLE

Transfer **100 µL** sample (supernatant enrichment culture, 20 to 24 h enrichment time) to a 1.5 mL reaction tube.

Note: For 25 g meat sample enrichment cultures with 8 h enrichment time, please take 500 µL.



3. CENTRIFUGE

5 min at 8,000 x g.

Note: If enrichment cultures are totally clear, centrifugation at $\geq 13,000 \times g$ is recommended.

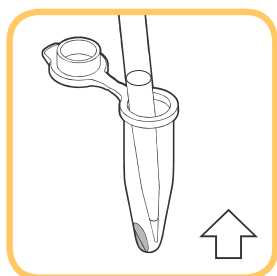

4. REMOVE SUPERNATANT

Discard liquid with a pipette immediately after centrifugation and inactivate appropriately.

Note: Take care that the tip of the pipette is on the opposite side of the pellet during pipetting.

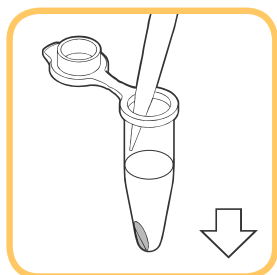

5. ADD LYSIS BUFFER

Transfer **200 µL** StarPrep Three Lysis Buffer to the sample tube.

Note: Use a magnetic stirrer (low speed) or gently shake the bottle with the lysis buffer for a short while.

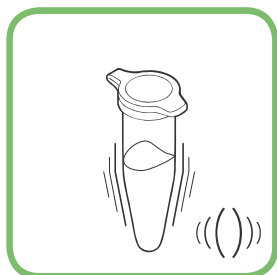

6. MIX

Vortex or mix by pipetting up and down until pellet has **completely resuspended**.

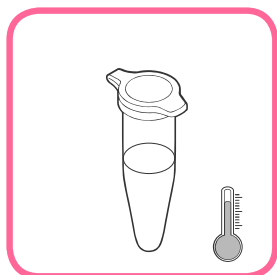

7. INCUBATE

10 min at 95 to 100 °C in a heating unit.

Carefully remove the reaction tube from the heating unit and allow the tube to sit for **1 min at 15 to 25 °C**.

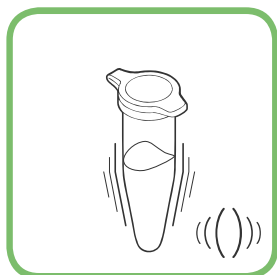

8. MIX

Vortex for **2 sec**.



9. CENTRIFUGE

2 min at 13,000 x g.

SUPERNATANT FOR DETECTION

Use up to 25 µL of extract for the foodproof LyoKits.

For PCR LyoKits 12.5 µL sample volume (+ 12.5 µL PCR-grade H₂O) instead of 25 µL is recommended, because inhibition of PCR might occur with DNA isolation sample volumes of 500 µL.

Note: Strictly avoid transferring fractions of the sediment to the PCR reaction, because this might cause PCR inhibition.

For later analysis, store DNA at -15 to -25 °C.

After thawing, mix briefly by vortexing and centrifuge at 13,000 x g for 2 min.



EXTRACTION PROCEDURE B: HIGH THROUGHPUT

2.3.2 EXTRACTION PROCEDURE B: HIGH THROUGHPUT

The following protocol describes the DNA isolation from 100 µL enrichment culture (20 - 24 h) or from 500 µL short time enrichment culture (8 h BPW enrichment) of meat samples.



1. SHAKE SAMPLE

Shake enrichment culture gently and let suspension settle for 5 to 10 min.

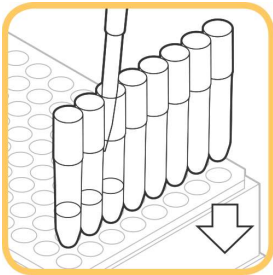

2. ADD SAMPLE

Transfer **100 µL** sample (enrichment culture supernatant) to the 8-tube strips.

Note: For 25 g meat sample enrichment cultures with 8 h enrichment time, please take 500 µL.

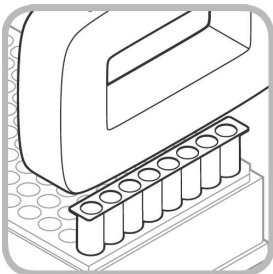

3. SEAL TUBES

Seal the tubes with sterile cap strips.

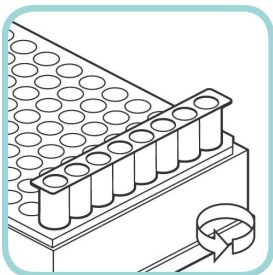

4. CENTRIFUGE RACK

10 min at 5,400 x g (or 25 min at 2,000 x g).

Make sure the rack is not sealed with rack lid during centrifugation.

Note: Time and g-force depend on the centrifuge (please see 2.1 Required Material for more information). Set the centrifuge acceleration to maximum speed and the brake to medium. If necessary, centrifugation forces should be calculated according to the centrifuge manual used.

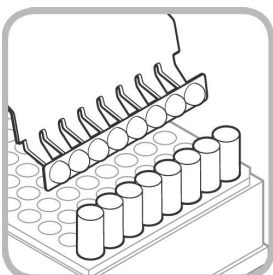

5. REMOVE CAPS

Remove and discard the 8-cap strips from the 8-tube strips.

To minimize the contamination risk, use the decapper 8-strip tool.

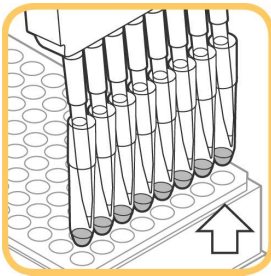
EXTRACTION PROCEDURE B: HIGH THROUGHPUT**6. REMOVE SUPERNATANT**

Remove supernatant with a multichannel pipette immediately after centrifugation, discard and inactivate appropriately.

Note: Take care that the tips of the pipette in the reaction tubes are not touching the pellets.

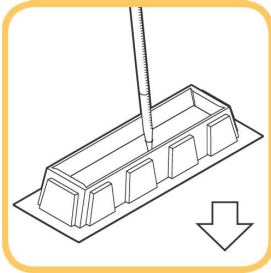
**7. PREPARE LYSIS BUFFER**

Transfer required lysis buffer to a sterile reservoir. Use **200 µL** lysis buffer per sample plus 1 mL lysis buffer as dead volume.

Note: Use a magnetic stirrer (low speed) or shake the bottle with lysis buffer gently in a short time interval to avoid sedimentation of ingredients.

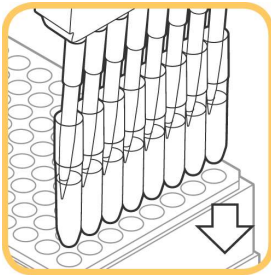
**8. ADD LYSIS BUFFER**

Pipet lysis buffer up and down 5 to 10 times in reservoir before using it to avoid sedimentation of ingredients.

Transfer **200 µL** lysis buffer with a multichannel pipette to each tube.

Resuspend pellets by pipetting up and down 5 to 10 times.

Note: For optimal DNA isolation efficiency, pellet has to be completely resuspended.

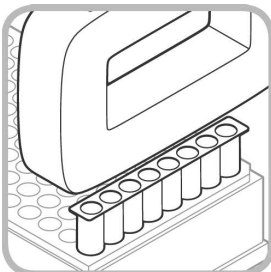
**9. SEAL TUBES**

Seal the tubes **tightly** with new sterile cap strips.

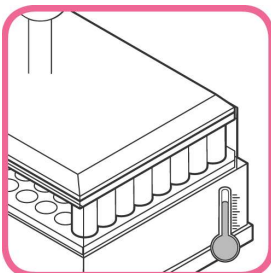
**10. INCUBATE**

Remove tube rack bottom and install incubation frame.

Incubate rack with tube stripes **10 - 15 min at 100 °C** in TH 21 Heating Block for 8-tube stripes.

Weight caps down with the lid weight.

Note: To avoid removing and reinstalling the bottom, it is possible to place tube stripes in an empty micro tube rack (with rack bottom removed).

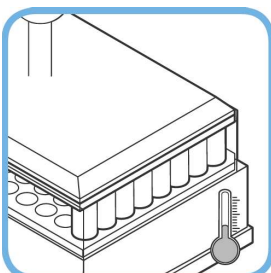
**11. CHILL**

Carefully **remove** the rack with the **tube strips together with the lid weight** from the heating unit and let it **cool 3 - 5 min at room temperature.**

To avoid opening of caps, do not remove the lid weight until the strips have cooled down.

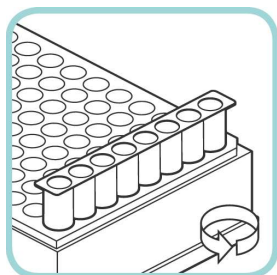
EXTRACTION PROCEDURE B: HIGH THROUGHPUT

12. CENTRIFUGE RACK

Reinstall tube rack bottom.

Centrifuge **5 min at 5,400 x g** (or 10 min at 2,000 x g).

Make sure the rack is not sealed with rack lid during centrifugation.

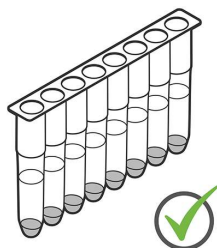

SUPERNATANT FOR DETECTION

Use up to 25 µL of the extract for the respective foodproof PCR LyoKit.

If sample volume has been 500 µL, 12.5 µL (+ 12.5 µL PCR-grade H₂O) are recommended for foodproof LyoKits.

Note: Strictly avoid transferring fractions of the sediment to the PCR reaction, because this might cause PCR inhibition.

For later analysis, store DNA at -15 to -25 °C.

After thawing, mix briefly by vortexing and centrifuge at 2,000 x g for 5 min.

Note: The sample is not purified. Proteins, RNA, and other materials remain in the sample. Long-term storage or archiving of prepared DNA samples is not recommended.

EXTRACTION PROCEDURE C: RAPID**2.3.3 EXTRACTION PROCEDURE C: RAPID**

This protocol is intended for rapid high-throughput extraction in combination with foodproof kits.

It is not suitable for all types of enrichment cultures. Please contact Hygiena for further information.

**1. SHAKE SAMPLE**

Shake enrichment culture gently and let suspension settle for 5 to 10 min.

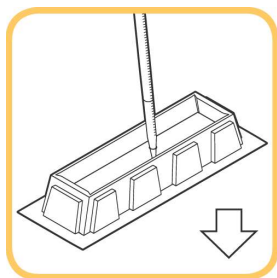
**2. PREPARE LYSIS BUFFER**

Transfer required lysis buffer to a sterile reservoir.

200 µL lysis buffer per sample plus **1 mL** lysis buffer as dead volume.

Note: Use a magnetic stirrer (low speed) or shake the bottle with lysis buffer gently in a short time interval to avoid sedimentation of ingredients.

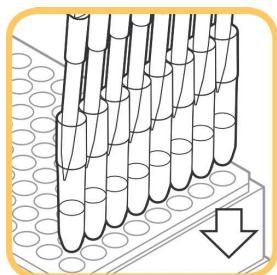
**3. ADD LYSIS BUFFER**

Pipet lysis buffer up and down 5 to 10 times in reservoir before using it to avoid sedimentation of ingredients.

Transfer **200 µL** lysis buffer with a multichannel pipette to each tube.

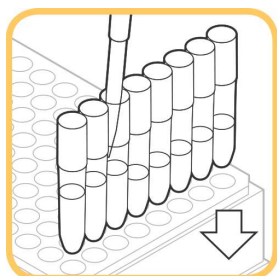
**4. ADD SAMPLE**

Transfer **50 µL** sample (enrichment culture supernatant) to the 8-tube strips.

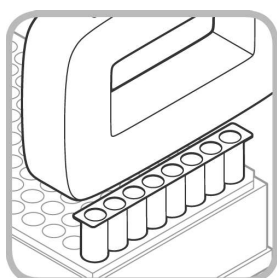
**5. SEAL TUBES**

Seal the tubes **tightly** with sterile cap strips.

EXTRACTION PROCEDURE C: RAPID

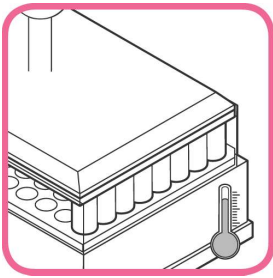

6. INCUBATE

Remove tube rack bottom and install incubation frame.

Incubate rack with tube stripes **10 - 15 min at 100 °C** in TH 21 Heating Block for 8-tube stripes.

Weight caps down with the lid weight.

Note: To avoid removing and reinstalling the bottom, it is possible to place tube stripes in an empty micro tube rack (with rack bottom removed).

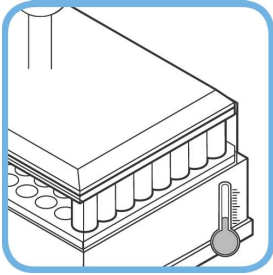

7. CHILL

Carefully **remove** the rack with the **tube stripes together with the lid weight** from the heating unit and let it **cool 3 - 5 min at room temperature**.

To avoid opening of caps, do not remove the lid weight until the stripes have cooled down.

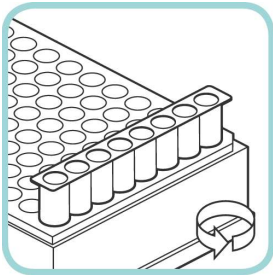

8. CENTRIFUGE RACK

Reinstall tube rack bottom.

Centrifuge **5 min at 2,000 x g**.

The rack must not be sealed with rack lid for centrifugation.

Note: Time and g-force depend on the centrifuge (please see 2.1. Required Material for more information). Set the centrifuge acceleration to maximum speed and the brake to medium. If necessary, centrifugation forces should be calculated according to the centrifuge manual used.

SUPERNATANT FOR DETECTION

Use up to 25 µL of the extract for the respective foodproof PCR LyoKit.

Note: Strictly avoid transferring fractions of the sediment to the PCR reaction, because this might cause PCR inhibition.

For later analysis, store DNA at -15 to -25 °C.

After thawing, mix briefly by vortexing and centrifuge at 2,000 x g for 5 min.

Note: The sample is not purified. Proteins, RNA, and other materials remain in the sample. Long-term storage or archiving of prepared DNA samples is not recommended.

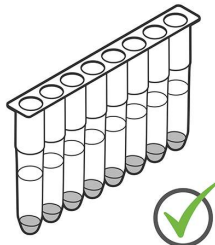

TROUBLESHOOTING

2.4 Troubleshooting

Problem	Possible Cause	Recommendation
Extract inhibits PCR	Enrichment culture or sample contains too many PCR inhibitors.	Perform a subcultivation, e.g., 1:10 dilution in fresh enrichment broth. Repeat DNA extraction with a reduced sample volume. For very cloudy supernatants, a reduction of the sample volume might enhance DNA isolation efficiency.
	DNA extract contains too many PCR inhibitors.	Dilute DNA extract, e.g., 1:10, or reduce the amount of extracted DNA, e.g., for LyoKits 5 µL + 20 µL PCR-grade H ₂ O instead of 25 µL
	Some of the centrifugation pellet transferred over to the PCR.	Always centrifuge the DNA sample before performing PCR. Use the top of the supernatant as a PCR template. Do not allow the filter tip to have contact with the pellet.
	Supernatants are not completely removed.	Remove supernatants completely.
Low DNA yield	Improper storage of kit components.	Store kit reagents at 15 to 25 °C.
	Enrichment culture contains substances that reduce the DNA extraction efficiency.	Perform a subcultivation or dilution, e.g., 1:10 in fresh enrichment broth.
	Sample contains substances that reduce the DNA extraction efficiency.	Reduce the sample volume. Important note: this will also reduce sensitivity.
	Not enough target organisms in enrichment culture.	Prolong the incubation phase.
	Pellet resuspension incomplete.	Improve resuspension by prolonged pipetting or vortexing.
	Suboptimal reaction conditions.	Ensure proper heating conditions. Verify correct temperature of the heating block with a thermometer.
Lid of the reaction tube opens during or after heating	Reaction tube not firmly closed.	Ensure that all reaction tubes are firmly closed before heating. Use lid clips for closing the tubes properly. Use a heating unit that enables removal of the tubes without directly touching the tube lids.

INSTRUCTIONS

2.5 Support

If you have questions or experience any problems with our products, please contact us:



www.hygiena.com/support

Our aim is to provide you with a solution as quickly and effectively as possible. We would also like you to contact us if you have any suggestions for improving the product or in case you would like to use our product for a different application. We highly value your feedback.

ADDITIONAL INFORMATION

3. ADDITIONAL INFORMATION

3.1 General Information

Quality Control

All products are regularly monitored by our quality control. You can find the certificate of analysis (COA) on our website. If you would like to carry out your own quality control, you will find the analysis method described in the certificate.

Waste Disposal

All contaminated and potentially infectious material, like enrichment cultures or food samples, should be autoclaved before disposal and eliminated according to local rules and regulations. For proper disposal of unused chemicals, please refer to the SDS.

Warranty and Disclaimer of Liability

“Limited Warranty” and “Disclaimer of Liability”: Hygiena Diagnostics GmbH warrants that this product is free from defects in materials and workmanship through the expiration date printed on the label and only if the following are complied with:

- (1) The product is used according to the guidelines and instructions set forth in the product literature;
- (2) Hygiena Diagnostics GmbH does not warrant its product against any and all defects when: the defect is as a result of material or workmanship not provided by Hygiena Diagnostics GmbH; defects caused by misuse or use contrary to the instructions supplied, or improper storage or handling of the product;
- (3) All warranties of merchantability and fitness for a particular purpose, written, oral, expressed or implied, shall extend only for a period of one year from the date of manufacture. There are no other warranties that extend beyond those described on the face of this warranty;
- (4) Hygiena Diagnostics GmbH does not undertake responsibility to any purchaser of its product for any undertaking, representation or warranty made by any dealers or distributors selling its products beyond those herein expressly expressed unless expressed in writing by an officer of Hygiena Diagnostics GmbH;
- (5) Hygiena Diagnostics GmbH does not assume responsibility for incidental or consequential damages, including, but not limited to responsibility for loss of use of this product, removal or replacement labor, loss of time, inconvenience, expense for telephone calls, shipping expenses, loss or damage to property or loss of revenue, personal injuries or wrongful death;
- (6) Hygiena Diagnostics GmbH reserves the right to replace or allow credit for any modules returned under this warranty.

ADDITIONAL INFORMATION

Trademarks

foodproof®, microproof®, vetproof®, ShortPrep®, StarPrep®, RoboPrep® and LyoKit® are registered trademarks of Hygiena Diagnostics GmbH.

Hygiena® is a registered trademark of Hygiena.

Other brand or product names are trademarks of their respective holders.

3.2 Reference

The reference number and original Hygiena Diagnostics GmbH article numbers: S 400 18 (KIT230187) and S 400 18 L (KIT230188)

3.3 Change Index

Revision A, September 2023:

New document and assay.

Hygiena®

Camarillo, CA 93012
USA

diagnostics.support@hygiena.com

Manufactured by
Hygiena Diagnostics GmbH

Hermannswerder 17
14473 Potsdam
Germany

www.hygiena.com