

foodproof[®]

StarPrep[®] Two Kit

Clostridium botulinum

PRODUCT INSTRUCTIONS

Documentation for the rapid extraction of DNA from
Clostridium botulinum for direct use in PCR.

Product No.: KIT230177

foodproof[®]
StarPrep[®] Two Kit
Clostridium botulinum

Store kit at 15 °C to 25 °C
FOR *IN VITRO* USE ONLY

Product No.: KIT230177
42 mL volume

Product Instructions:
Revision A, November 2023

TABLE OF CONTENTS

1. OVERVIEW 4

1.1 General Information..... 4

1.2 Applicability 4

1.3 Kit Contents..... 5

2. INSTRUCTIONS 6

2.1 Required Material 6

2.2 Precautions and Preparations 7

2.3 Workflows..... 8

 2.3.1 Extraction Procedure: STANDARD..... 8

2.4. Troubleshooting..... 11

2.5 Support..... 12

3. ADDITIONAL INFORMATION 13

3.1 General Information..... 13

3.2 Reference Number 14

3.3 Change Index 14

OVERVIEW

1. OVERVIEW

The foodproof® StarPrep® Two Kit is designed for the rapid preparation of DNA from bacteria for direct use in PCR. The extracted DNA can be used directly in any PCR application. The StarPrep Two Lysis Buffer eliminates the need for hazardous organic extractions or chaotropic agents. The entire DNA preparation can be performed in a single tube, minimizing handling steps and exposure to hazardous material. The reduced number of handling steps saves time. Transfer steps of DNA-containing extracts are not necessary, thus cross-contamination risks are minimized.

1.1 General Information

Number of Reactions

The kit is designed for 96 reactions.

Storage Conditions

Store at 15 to 25 °C.

The components of the foodproof StarPrep Two Kit are guaranteed to be stable through the expiration date printed on the label.

1.2 Applicability

The lysis buffer can be used to prepare DNA from up to 800 µL sample. For very cloudy supernatants a reduction of the sample volume (e.g., 200 µL) may enhance the DNA isolation efficiency. The lysis buffer is optimized for the preparation of various types of sample material. The quality of the DNA obtained with the lysis buffer is suitable for any PCR application.

OVERVIEW

1.3 Kit Contents

A schematic representation of the foodproof StarPrep Two Kit with all its components.

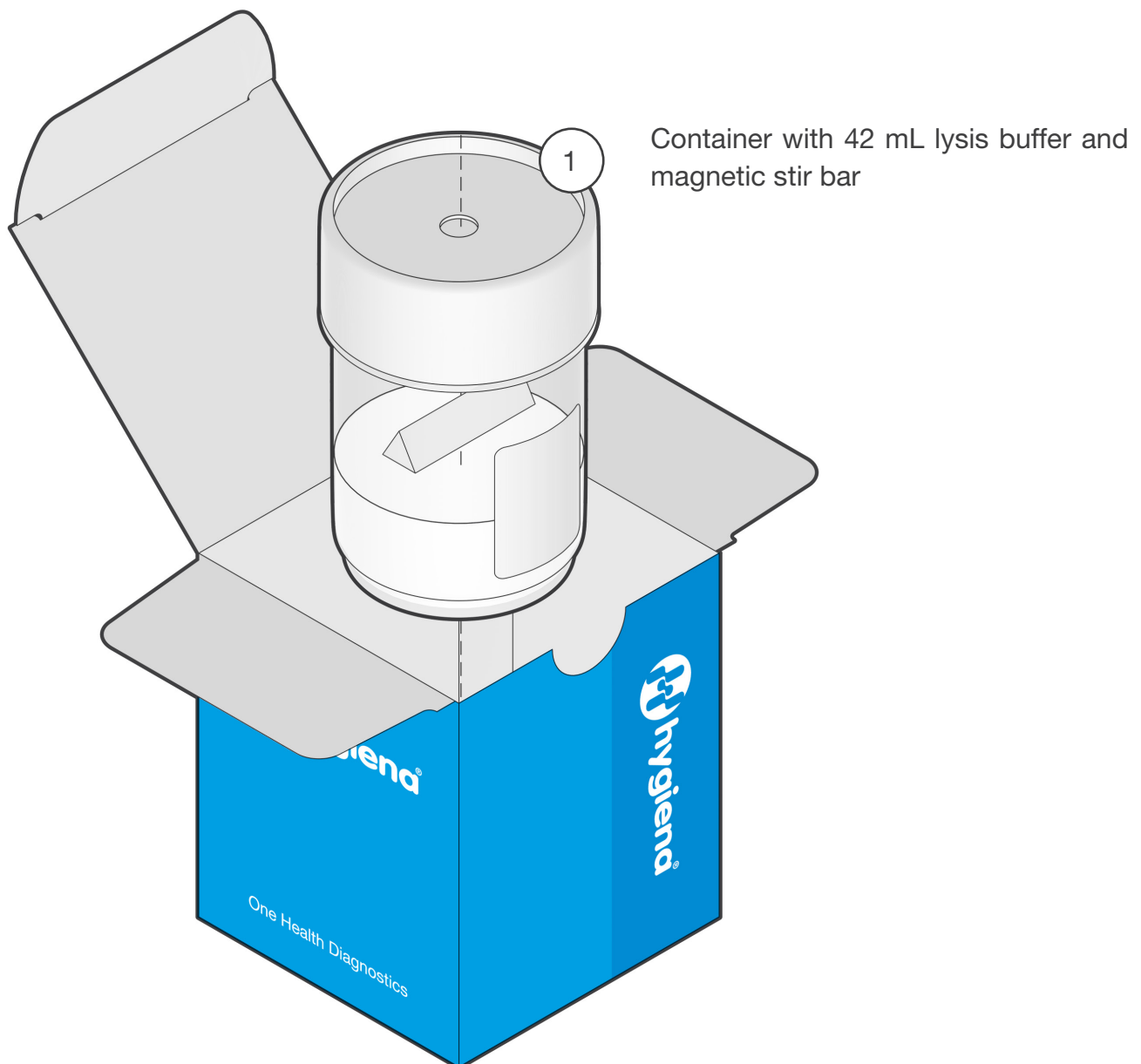

INSTRUCTIONS

2. INSTRUCTIONS

This section provides all information for a seamless DNA extraction from a variety of matrices.

2.1 Required Material

Most of the required equipment and reagents are available through Hygiena®. Please contact us for further information.



It is highly recommended only to use the materials described below to guarantee the robustness of the method.

Reagents

 Resuspension Reagent

Product No. KIT230010

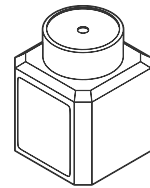

Equipment

 Standard tabletop **microcentrifuge** capable of a 13,000 × g centrifugal force

e.g., Micro Star 17 - VWR

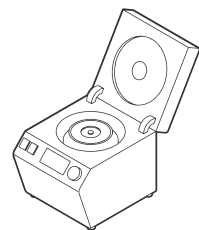
 Unit for **mechanical cell disruption** suitable for working with 1.5 mL reaction tubes

*e.g., Mortexer™ - Benchmark Scientific
or Disruptor Genie® - Scientific Industries*

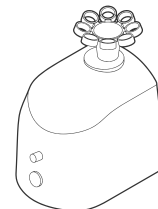
 **Heating unit** suitable for 2 mL reaction tubes

e.g., AccuBlock™ - Labnet with heating block

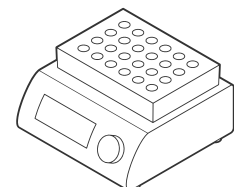

INSTRUCTIONS

Magnetic stirrer

e.g., color squid IKAMAG® - IKA®-Werke

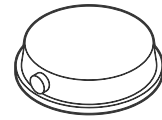

Vortex mixer

e.g., Vortex-Genie - Scientific Industries

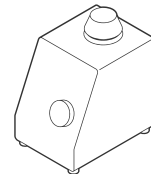

2.2 Precautions and Preparations

Follow all universal safety precautions governing work with biohazardous materials, e.g., wear lab coats and gloves at all times. Properly dispose of all contaminated materials, decontaminate work surfaces, and use a biosafety cabinet whenever aerosols might be generated.

For more information, please refer to the appropriate material safety data sheet (SDS). The SDS is available online at www.hygiena.com/sds.

Always use filter tips in order to avoid cross-contamination.



Mix thoroughly while pipetting the buffer for sample preparation. It is not recommended to use more than 96 reactions. The container must retain some of the reagent. Do not use anymore reagent once the minimum level mark on the container has been reached. The mark indicates the minimal allowed pipetting level while the stirrer is not in use.

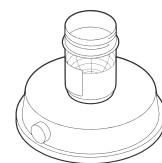

Set the heating unit to 95 to 100 °C.

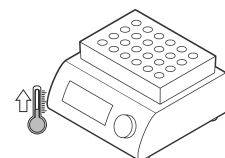

EXTRACTION PROCEDURE: STANDARD

2.3 Workflows

The following procedure describes the DNA isolation from enrichment cultures.

2.3.1 EXTRACTION PROCEDURE: STANDARD

This protocol describes the DNA isolation from 800 µL enrichment culture. This fast protocol only needs a few pipetting steps. It includes an additional washing step to reduce inhibitory effects originating from the matrix or enrichment culture media.

This protocol is recommended for use with difficult matrices or large sample volumes.

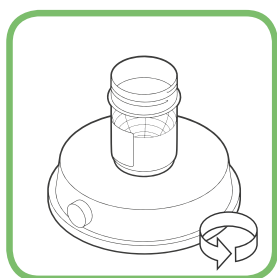

1. PREPARE LYSIS BUFFER

Place closed lysis buffer container on the magnetic stirrer.

Continuously mix lysis buffer at 400 rpm on the magnetic stirrer to keep solution homogeneous.

Open the lysis buffer container.

Note: Hold the container while switching on the magnetic stirrer and during pipetting.

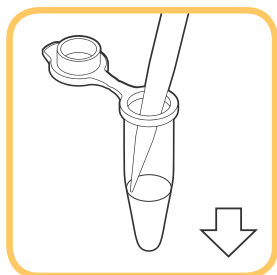

2. ADD LYSIS BUFFER TO A NEW TUBE

Transfer **300 µL** lysis buffer to a 1.5 mL reaction tube.

Note: Depending on mechanical disruption unit it is also possible to use 2 mL reaction tubes. Pipet carefully and vertically along the lysis buffer container wall, approximately 0.5 cm above the bottom. Use a 1,000 µL filter tip to transfer lysis buffer to the sample.



3. SHAKE SAMPLE

Shake enrichment culture gently and let the suspension settle for 5 to 10 min.

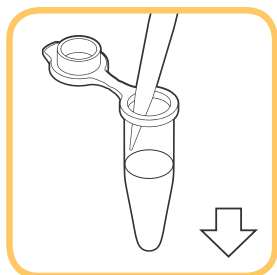

4. ADD SAMPLE

Transfer **up to 800 µL** sample (supernatant enrichment culture) to the reaction tube containing the lysis buffer.

Note: For very cloudy supernatants, a reduction of the sample volume (e.g., 200 µL) may enhance the DNA isolation efficiency.

EXTRACTION PROCEDURE: STANDARD**5. CENTRIFUGE**

5 min at 8,000 x g.

Note: If necessary, centrifugation forces should be calculated according to the centrifuge manual used.

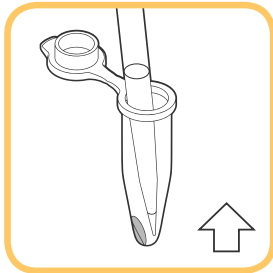
**6. REMOVE SUPERNATANT**

Discard liquid with a pipette immediately after centrifugation and inactivate appropriately.

Note: Take care that the tip of the pipette does not touch the bottom layer containing the lysis beads.

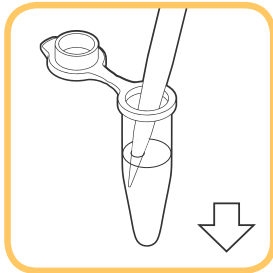
**7. WASH PELLET**

Transfer **800 µL** sterile double-distilled water and resuspend pellet by pipetting gently up and down. Do not vortex.

Note: For optimal efficiency, the pellet has to be completely resuspended.

**8. CENTRIFUGE**

5 min at 8,000 x g.

Note: If necessary, centrifugation forces should be calculated according to the manual of the used centrifuge.

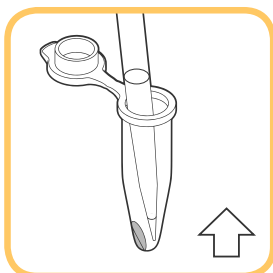
**9. REMOVE SUPERNATANT**

Discard liquid with a pipette immediately after centrifugation and inactivate appropriately.

Note: Take care that the tip of the pipette is on the opposite side of the pellet during pipetting.

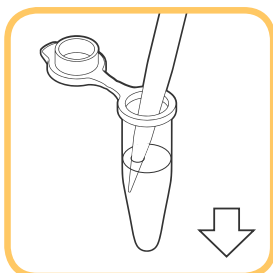
**10. ADD RESUSPENSION REAGENT**

Transfer **300 µL** Resuspension Reagent to the sample tube and resuspend pellet by vortexing or pipetting gently up and down.

Note: For optimal efficiency, the pellet has to be completely resuspended.

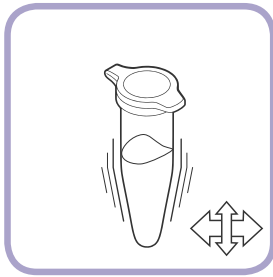
EXTRACTION PROCEDURE: STANDARD

11. MECHANICAL DISRUPTION

Place tube in a cell disruption unit and perform disruption:

Disruptor device: 8 min at maximum speed.

Note: The efficiency of disruption depends on the mechanical cell disruption unit.

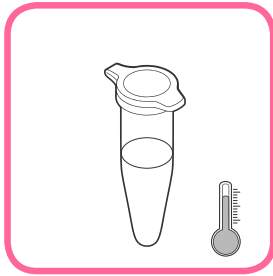

12. INCUBATE

5 min at 95 to 100 °C in a heating unit.

Carefully remove the reaction tube from the heating unit and allow the tube to sit for **1 min at 15 to 25 °C**.

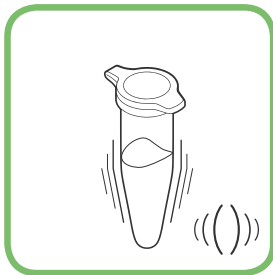

13. MIX

Vortex for 2 sec.



14. CENTRIFUGE

5 min at 13,000 x g.

Note: If necessary, centrifugation forces should be calculated according to the centrifuge manual used.

SUPERNATANT FOR DETECTION

Use extract for the foodproof PCR kits.

Strictly avoid transferring fractions of the sediment to the PCR reaction, because this might cause PCR inhibition.

For later analysis, store DNA at -15 to -25 °C.

After thawing, mix briefly by vortexing and centrifuge at 13,000 x g for 2 min.

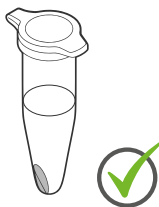

TROUBLESHOOTING

2.4. Troubleshooting

Problem	Possible Cause	Recommendation
Extract inhibits PCR	Enrichment culture or sample contains too many PCR inhibitors.	Perform a subcultivation, e.g., 1:10 dilution in fresh enrichment broth. Repeat DNA extraction with reduced sample volume.
	DNA extract contains too many PCR inhibitors.	Dilute DNA extract, e.g., 1:10, or reduce the amount of extracted DNA, e.g., for LyoKits 5 µL instead of 25 µL.
	Some of the centrifugation pellet transferred over to the PCR.	Always centrifuge the DNA sample before performing PCR. Use the top of the supernatant as a PCR template. Do not allow the filter tip to have contact with the pellet.
Low DNA yield	Improper storage of kit components.	Store kit reagents at 15 to 25 °C.
	Enrichment culture contains substances that reduce the DNA extraction efficiency.	Perform a subcultivation or dilution, e.g., 1:10 in fresh enrichment broth.
	Sample contains substances that reduce the DNA extraction efficiency.	Reduce the sample volume.
	Not enough target organisms in enrichment culture.	Prolong the incubation phase.
	Pellet resuspension incomplete.	Improve resuspension by prolonged pipetting or vortexing.
	No or insufficient beads in the reaction.	Use correct stirring settings. Do not pipette more than 96 / 192 (depending on protocol) reactions. Do not use reagent below the minimal level indicated
	Suboptimal reaction conditions.	Ensure proper disruption and heating conditions. Verify correct temperature of the heating block with a thermometer.
Lid of the reaction tube opens during or after heating	Reaction tube not firmly closed.	Use lid clips for closing the tubes properly. Use a heating unit that enables removal of the tubes without directly touching the tube lids.

2.5 Support

If you have questions or experience any problems with our products, please contact us:



www.hygiena.com/support

Our aim is to provide you with a solution as quickly and effectively as possible. We would also like you to contact us if you have any suggestions for improving the product or in case you would like to use our product for a different application. We highly value your feedback.

ADDITIONAL INFORMATION

3. ADDITIONAL INFORMATION

3.1 General Information

Quality Control

All products are regularly monitored by our quality control. You can find the certificate of analysis (COA) on our website. If you would like to carry out your own quality control, you will find the analysis method described in the certificate.

Waste Disposal

All contaminated and potentially infectious material, like enrichment cultures or food samples, should be autoclaved before disposal and eliminated according to local rules and regulations. For proper disposal of unused chemicals, please refer to the SDS.

Warranty and Disclaimer of Liability

“Limited Warranty” and “Disclaimer of Liability”: Hygiena Diagnostics GmbH warrants that this product is free from defects in materials and workmanship through the expiration date printed on the label and only if the following are complied with:

- (1) The product is used according to the guidelines and instructions set forth in the product literature;
- (2) Hygiena Diagnostics GmbH does not warrant its product against any and all defects when: the defect is as a result of material or workmanship not provided by Hygiena Diagnostics GmbH; defects caused by misuse or use contrary to the instructions supplied, or improper storage or handling of the product;
- (3) All warranties of merchantability and fitness for a particular purpose, written, oral, expressed or implied, shall extend only for a period of one year from the date of manufacture. There are no other warranties that extend beyond those described on the face of this warranty;
- (4) Hygiena Diagnostics GmbH does not undertake responsibility to any purchaser of its product for any undertaking, representation or warranty made by any dealers or distributors selling its products beyond those herein expressly expressed unless expressed in writing by an officer of Hygiena Diagnostics GmbH;
- (5) Hygiena Diagnostics GmbH does not assume responsibility for incidental or consequential damages, including, but not limited to responsibility for loss of use of this product, removal or replacement labor, loss of time, inconvenience, expense for telephone calls, shipping expenses, loss or damage to property or loss of revenue, personal injuries or wrongful death;
- (6) Hygiena Diagnostics GmbH reserves the right to replace or allow credit for any modules returned under this warranty.

ADDITIONAL INFORMATION

Trademarks

foodproof®, microproof®, vetproof®, ShortPrep®, StarPrep®, RoboPrep® and LyoKit® are registered trademarks of Hygiena Diagnostics GmbH.

Hygiena® is a registered trademark of Hygiena.

Other brand or product names are trademarks of their respective holders.

3.2 Reference Number

The reference number and original Hygiena Diagnostics GmbH

article number: S 400 08.1

3.3 Change Index

Version 1, December 2019:

New document layout and content.

Revision A, August 2023:

Rebranding and layout.

S 400 08-1 20-3 -> INS 230177-3-REVA

Hygiena®

Camarillo, CA 93012

USA

diagnostics.support@hygiena.com

Manufactured by Hygiena Diagnostics GmbH

Hermannswerder 17

14473 Potsdam

Germany

www.hygiena.com